



中国科学院
CHINESE ACADEMY OF SCIENCES



中国科学院近代物理研究所
Institute of Modern Physics, Chinese Academy of Sciences

Spin Physics at HIAF

Boxing Gou
on behalf of the HIAF spin team

Huizhou • March 30 - April 3, 2026
2nd Workshop on Polarized Beams and Targets (PBT2026)

➤ Efforts towards polarized beams/targets for HIAF

- Polarized ion sources
- Acceleration of polarized beams
- Beam polarimetry and polarized targets

➤ Spin physics at HIAF in the near future

- Atomic, nuclear and hadron physics
- New boson search
- Test of time-reversal symmetry
- **Spin-rotating polarized target**

Final-state polarization measurements not covered

[see talk by Yutie Liang \(Wednesday, morning\)](#)

HIAF-EicC

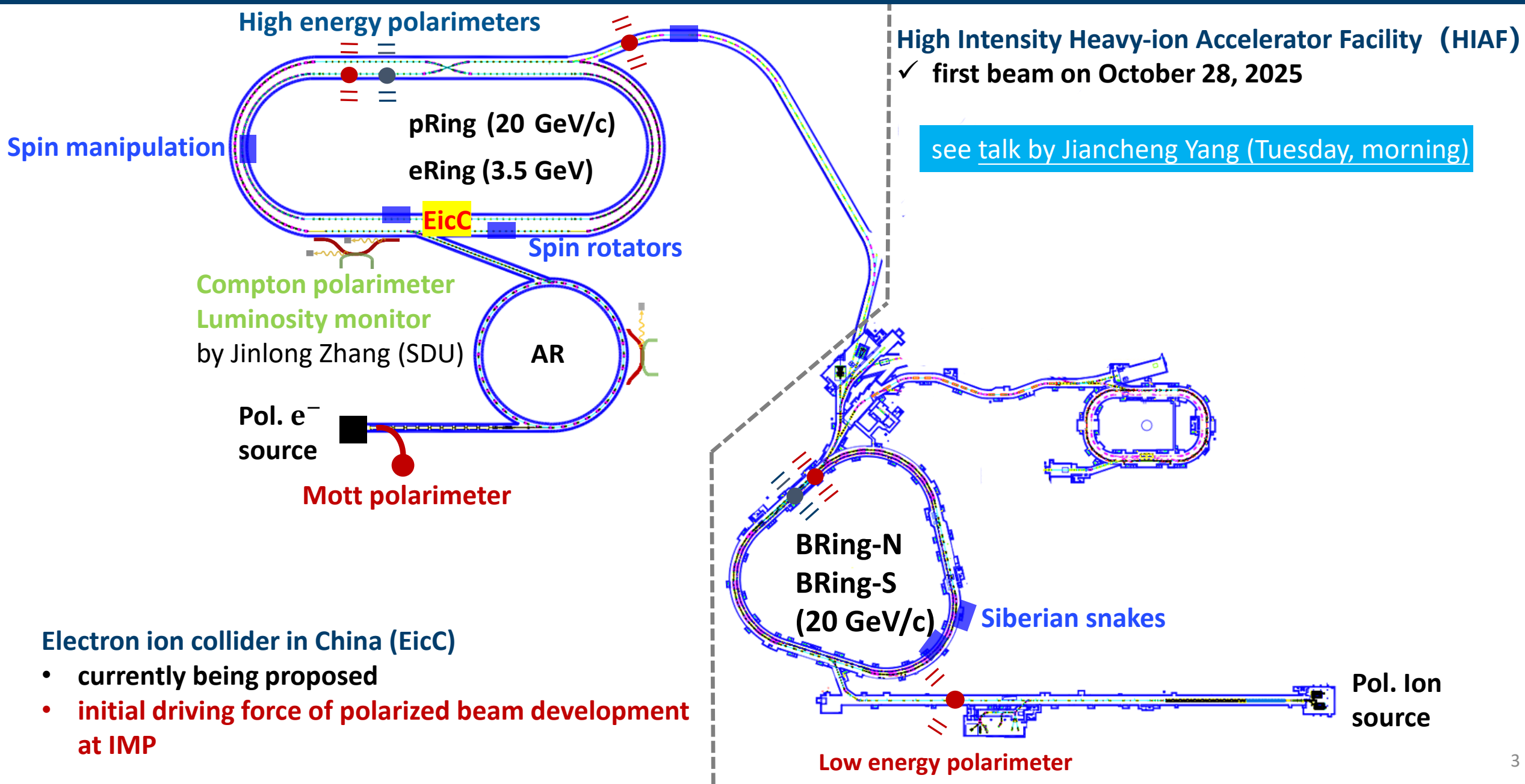

High Intensity Heavy-ion Accelerator Facility (HIAF)
✓ first beam on October 28, 2025

see talk by Jiancheng Yang (Tuesday, morning)

- Electron ion collider in China (EicC)
- currently being proposed
 - **initial driving force of polarized beam development at IMP**

- Efforts towards polarized beams/targets for HIAF
 - Polarized ion sources
 - Acceleration of polarized beams
 - Beam polarimetry and polarized targets

- Spin physics at HIAF in the near future
 - Atomic, nuclear and hadron physics
 - New boson search
 - Test of time-reversal symmetry
 - Spin-rotating polarized target

Efforts towards polarized beams/targets at HIAF

- A team for **polarized ion source**, **polarized beam acceleration** and **polarized target**
- International collaborations



team leader



pol. ^3He



engineering
vacuum



pol. H/D source

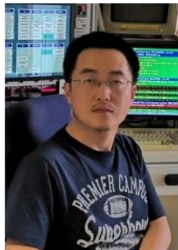

polarimeter
pol. H target

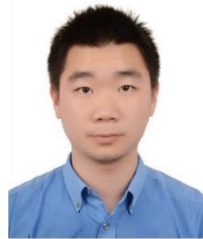

pol. ion source
pol. H target



magnet



beam diagnostic



polarimeter
pol. H target



pol. beam acc.
spin manipulation



ionizer
Lamb-Shift
polarimeter

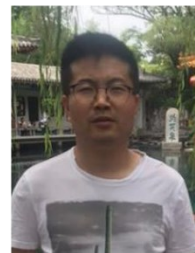

control system

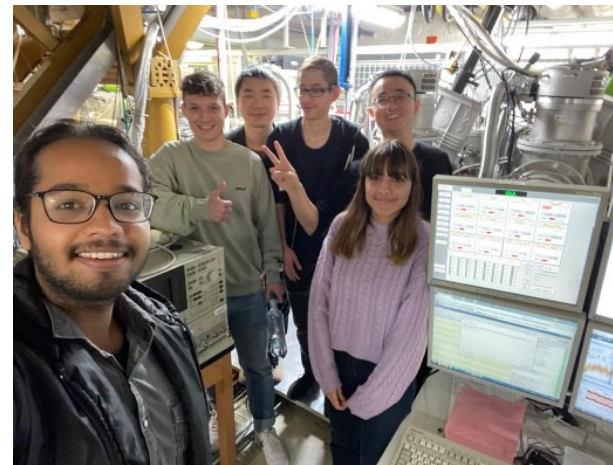

Efforts towards polarized beams/targets at HIAF

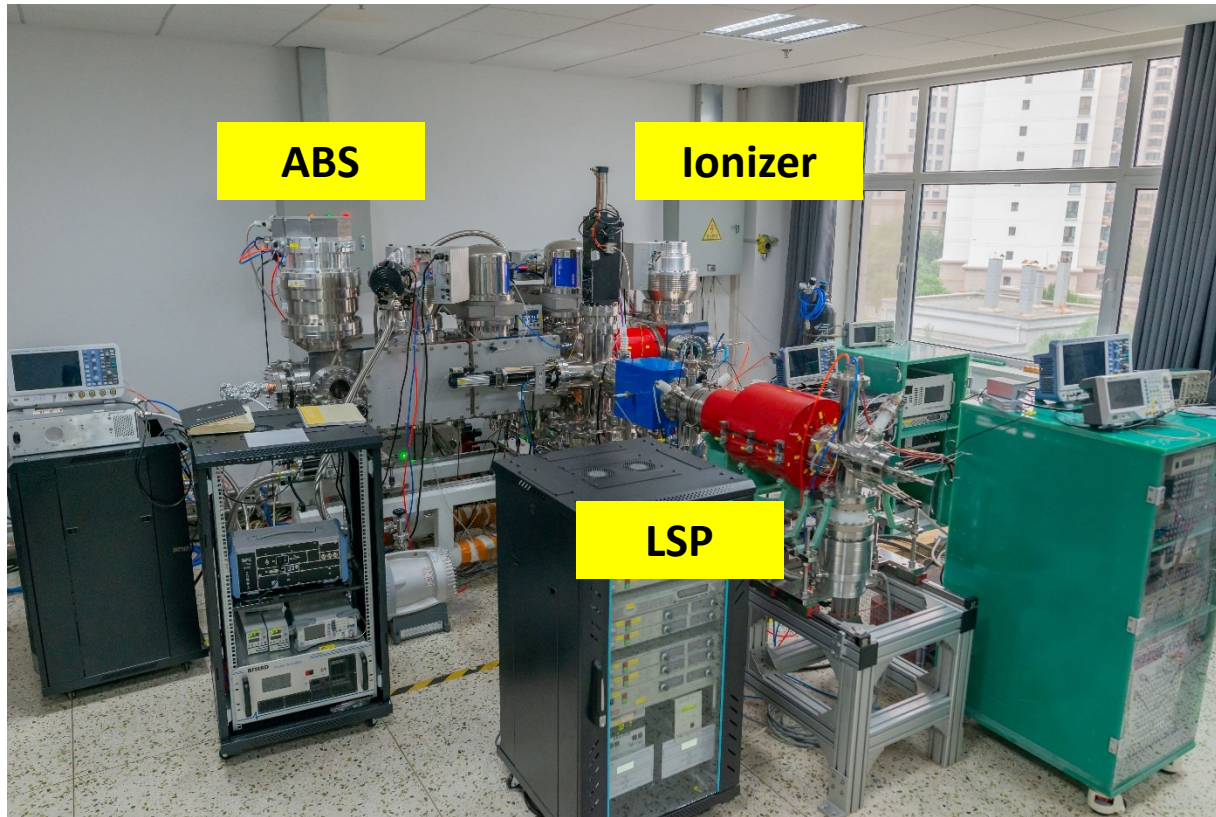

A polarized H^+/D^+ source already built at IMP

- Intensity: > 1 mA
- Polarization: $> 80\%$
- Repetition frequency: 2-5 Hz
- Pulse width: > 100 us

see [talk by Yaojie Zhai](#) (Wednesday, morning)

Polarized beam acceleration at HIAF investigated by Minxiang Li et al.

- constant field solenoid Siberian snake: [NIMA 1031, 166405 \(2022\)](#)
- tensor-polarized deuteron beam: [Phys. Rev. Accel. Beams 28, 094002](#)

PIT design in progress

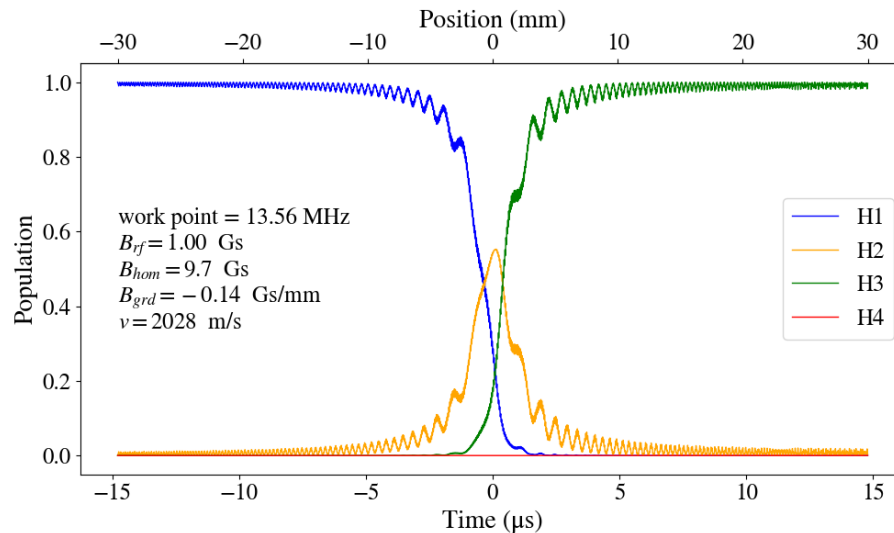
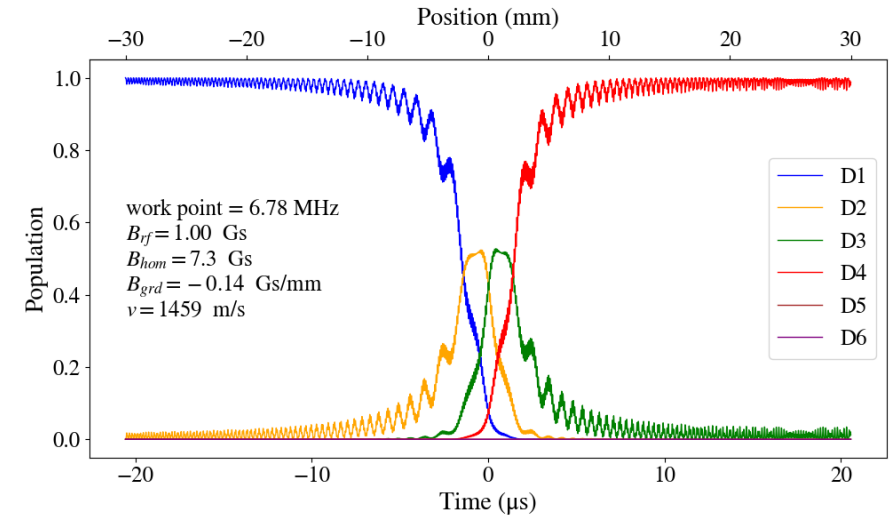
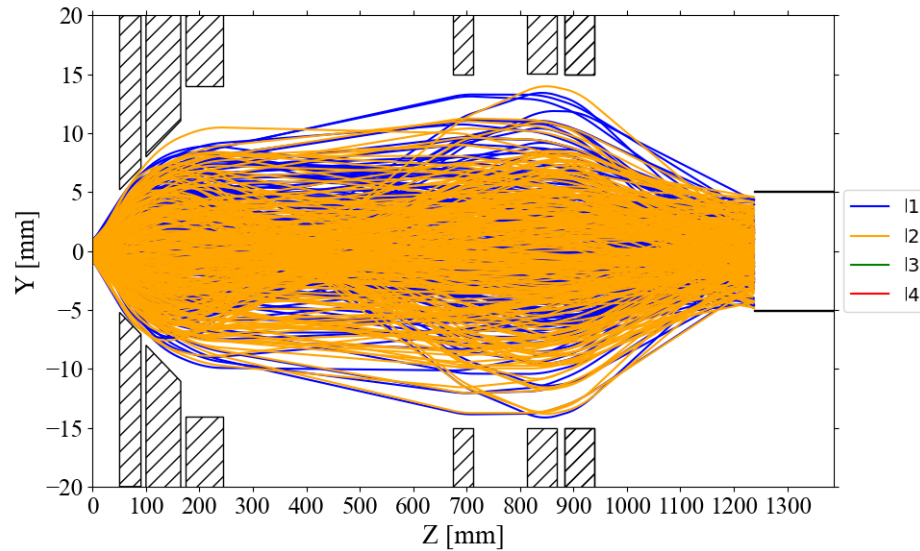
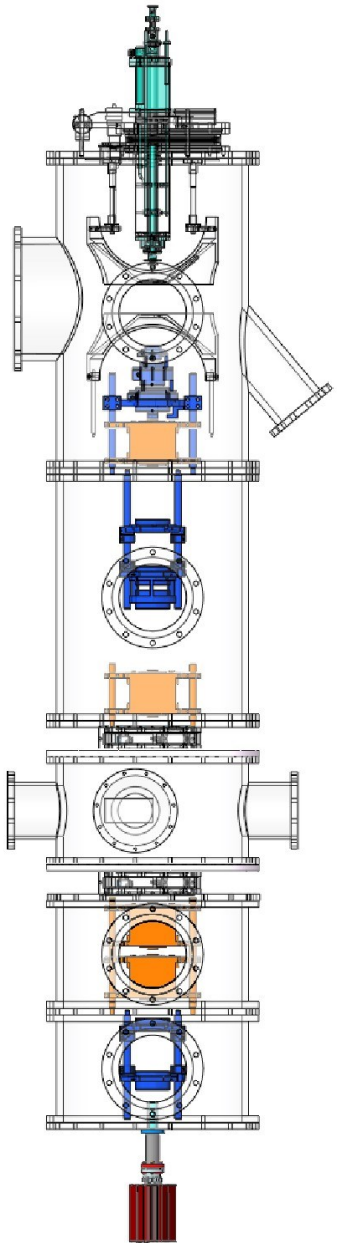

PIT design in progress

- ✓ Preliminary mechanical design
- ✓ Atomic tracking in sextuple magnet
- ✓ Zeeman transition in RF units

[see poster by Xiaorong Lv](#)

- Efforts towards polarized beams/targets for HIAF
 - Polarized ion sources
 - Acceleration of polarized beams
 - Beam polarimetry and polarized targets

- Spin physics at HIAF in the near future
 - Atomic, nuclear and hadron physics
 - New boson search
 - Test of time-reversal symmetry
 - Spin-rotating polarized target

Spin physics at HIAF

- A kick-off workshop (PBT2024)
- Productive discussions about spin physics at HIAF
- Nice physics identified



The 1st Workshop on Polarized Beam and Target - Physics and Applications (PBT2024)

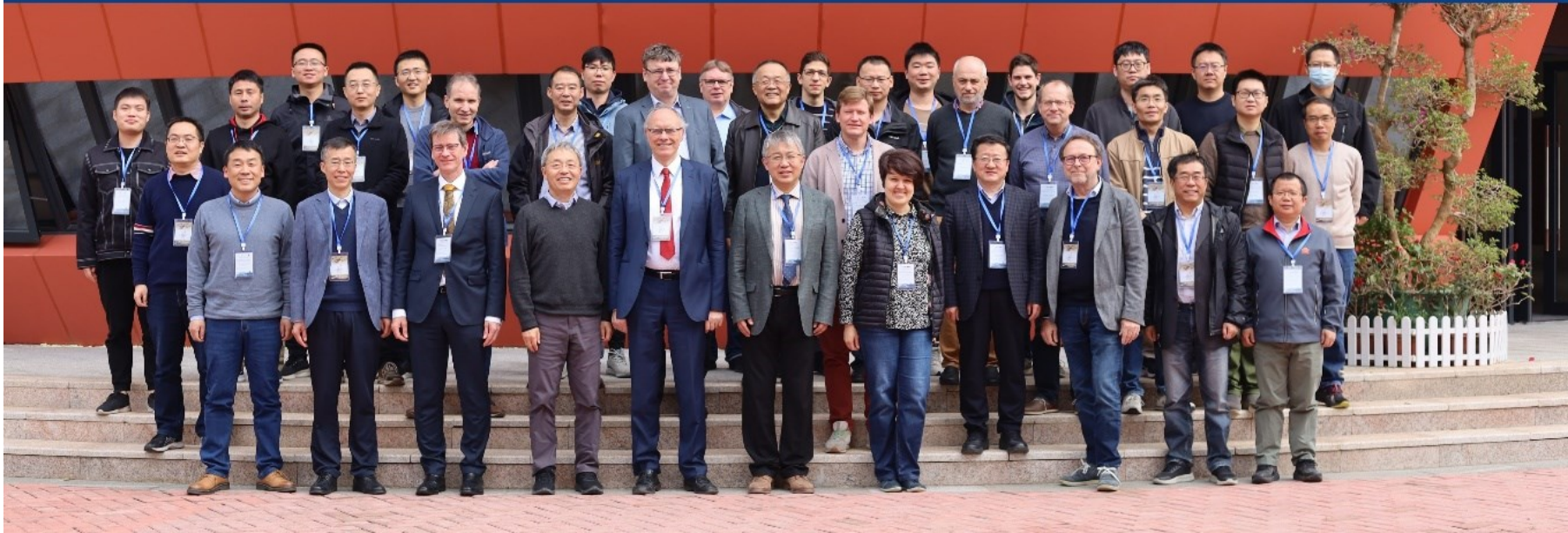

Spin physics at HIAF

- A kick-off workshop (PBT2024)
- Productive discussions about spin physics at HIAF



➤ PBT2026

- new ideas
- innovative techniques
- more exciting physics

The 2nd Workshop on Polarized Beam and Polarized Target – Physics and Application (PBT2026)

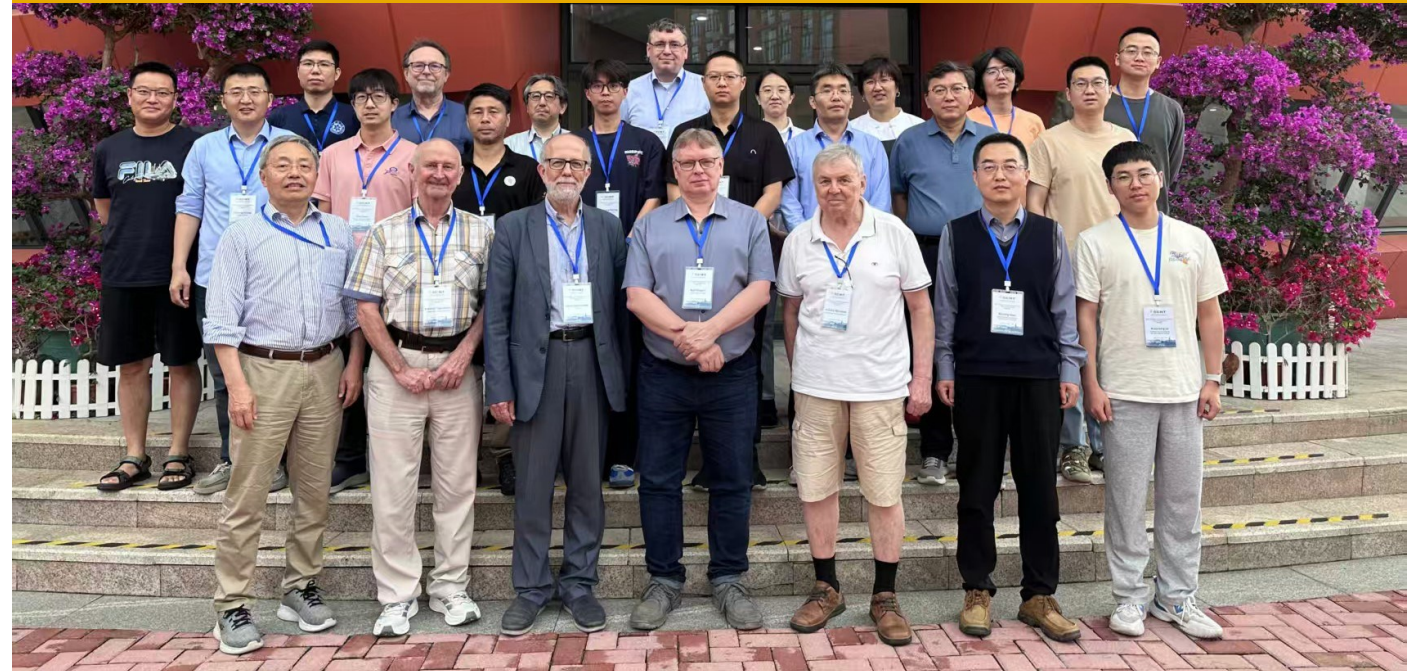

Highlights

- Polarized gas target will be used as both **proton target** and **electron target**

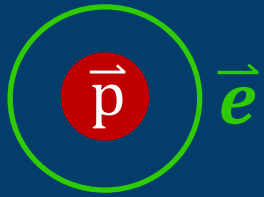

- Spin degree of freedom in atomic/nuclear physics
- Beyond SM physics

① pol. e target

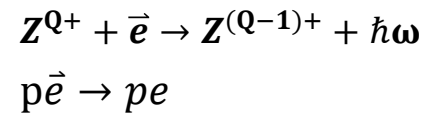

unpol. beams (A, p)

pol. electron capture (atomic physics)
 proton EM radii, new boson search (BSM boson)

② pol. p target

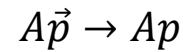

unpol. heavy ion beams (C, Ca, Au, ...)

→ many body structure
 nuclear physics

③ heavy target

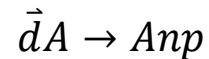

pol. d beams

EOS

nuclear physics

④ pol. p target

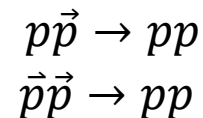

pol. p beams

A_N }
 A_{NN} } → NN spin dynamics
 glueball in t channel
 hadron physics

⑤ pol. d target

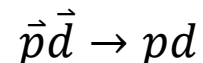

pol. p beams

test of time reversal symmetry (T symmetry)

Polarized e^- capture

see [talk by Thomas Stöhlker](#) (Thursday, morning)

REC with pol. e target

➤ Radiative electron capture (REC): $Z^{Q+} + e^- \rightarrow Z^{(Q-1)+} + \hbar\omega + \dots$

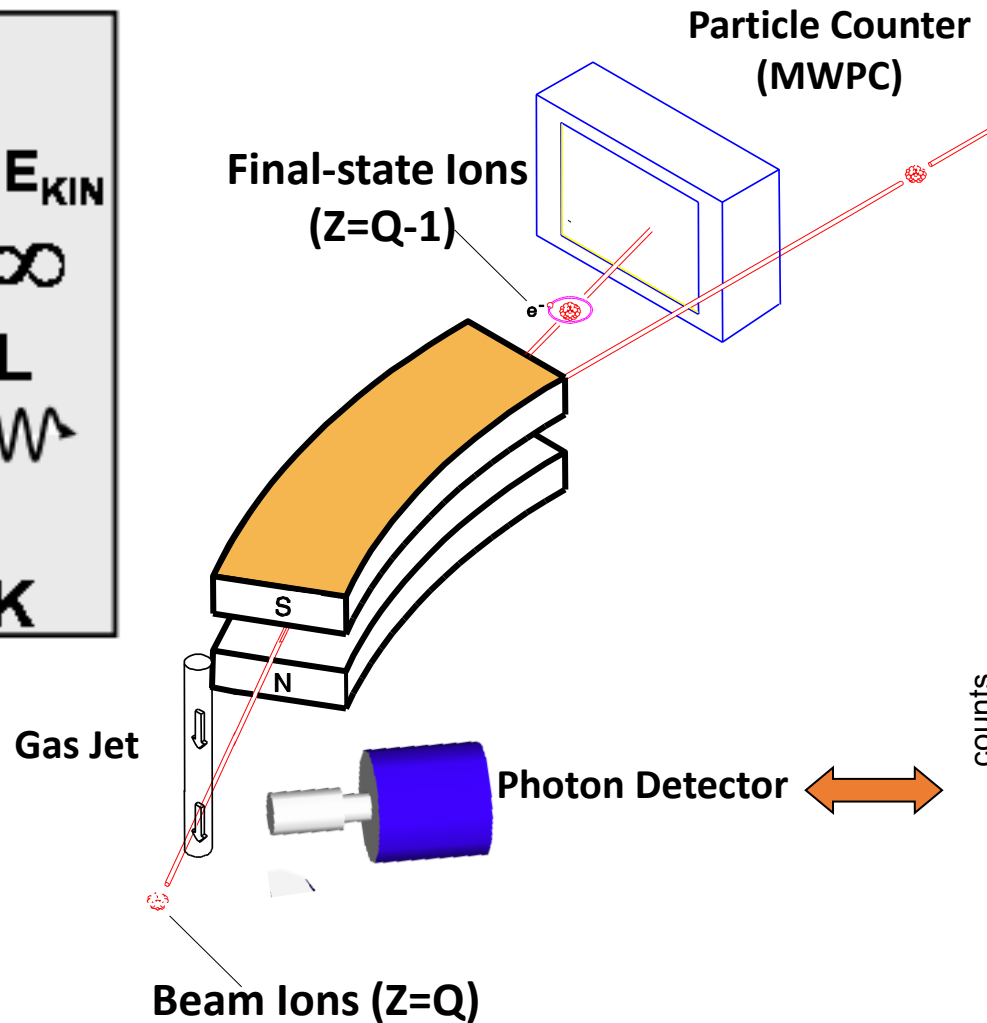
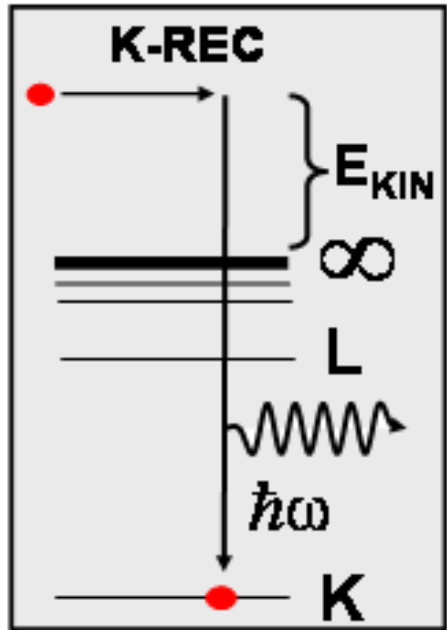

courtesy of Prof. Thomas Stöhlker and Dr. Anna Mayorova

U⁹²⁺ + N₂ @ 295 MeV/u

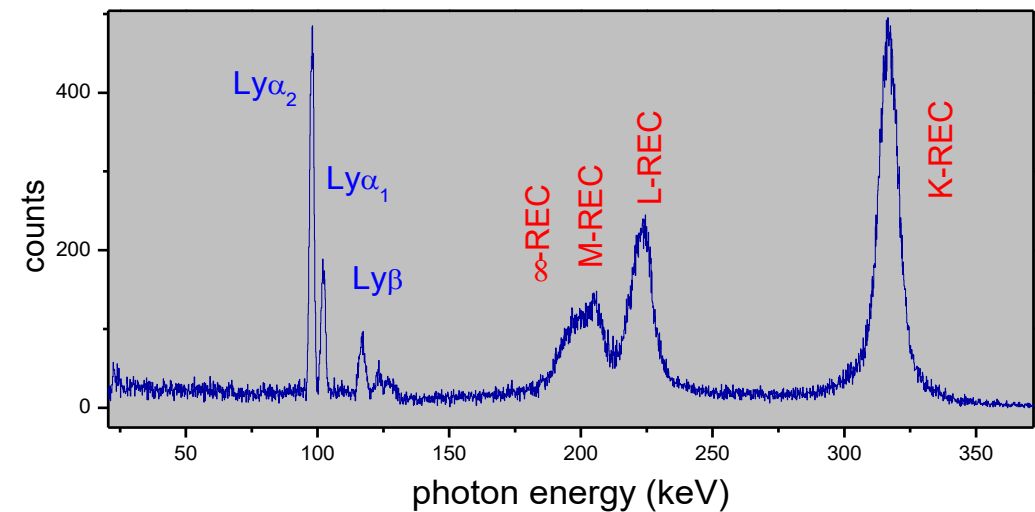

REC with pol. e target

- Radiative electron capture (REC): $Z^{Q+} + e^{-} \rightarrow Z^{(Q-1)+} + \hbar\omega + \dots$
- Sensitive to ion and electron spin states

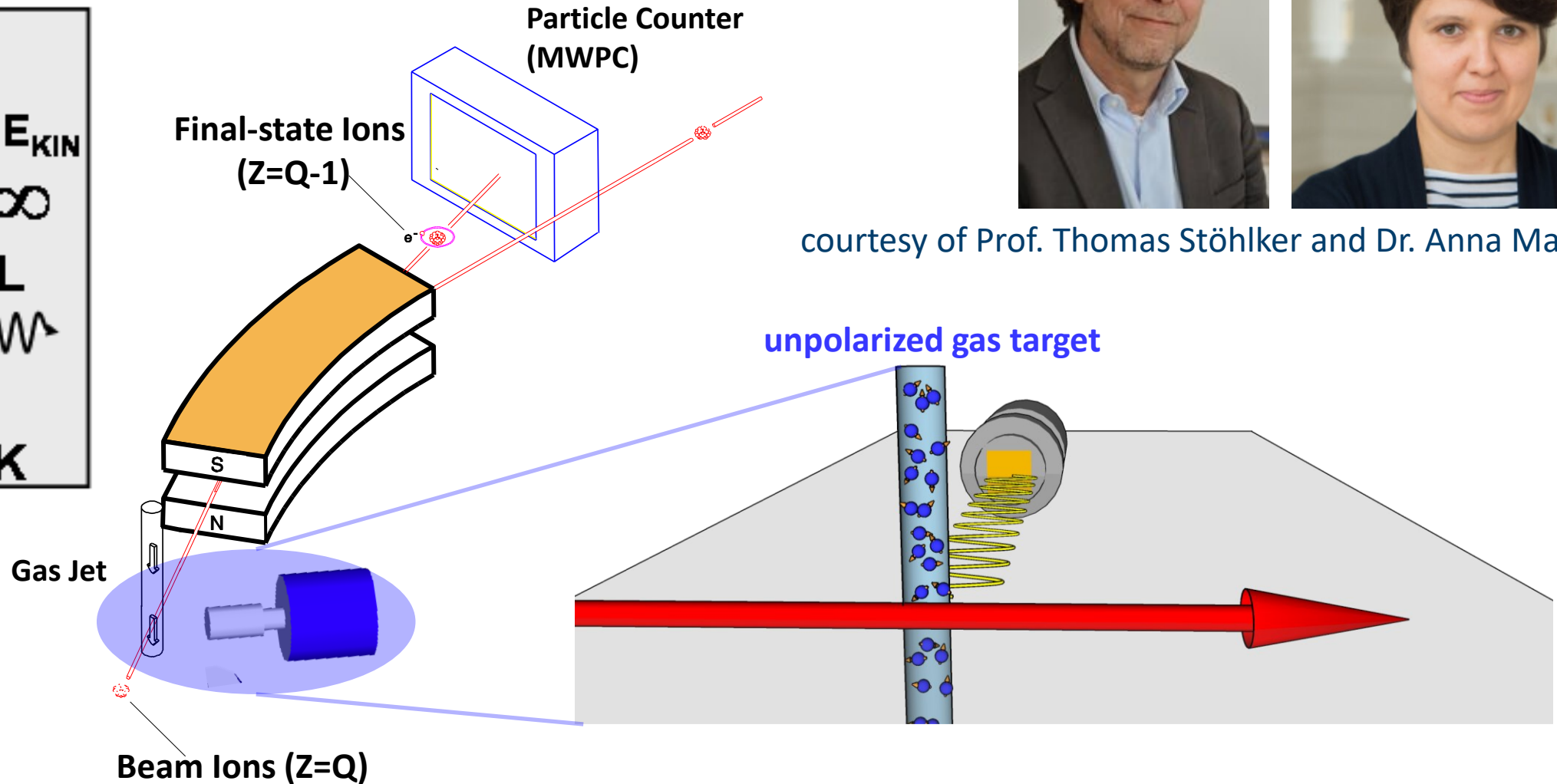
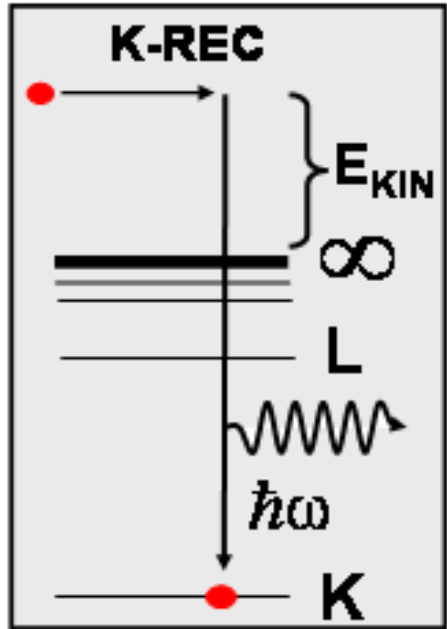

courtesy of Prof. Thomas Stöhlker and Dr. Anna Mayorova

REC with pol. e target

- Radiative electron capture (REC): $Z^{Q+} + e^- \rightarrow Z^{(Q-1)+} + \hbar\omega + \dots$
- Sensitive to ion and electron spin states

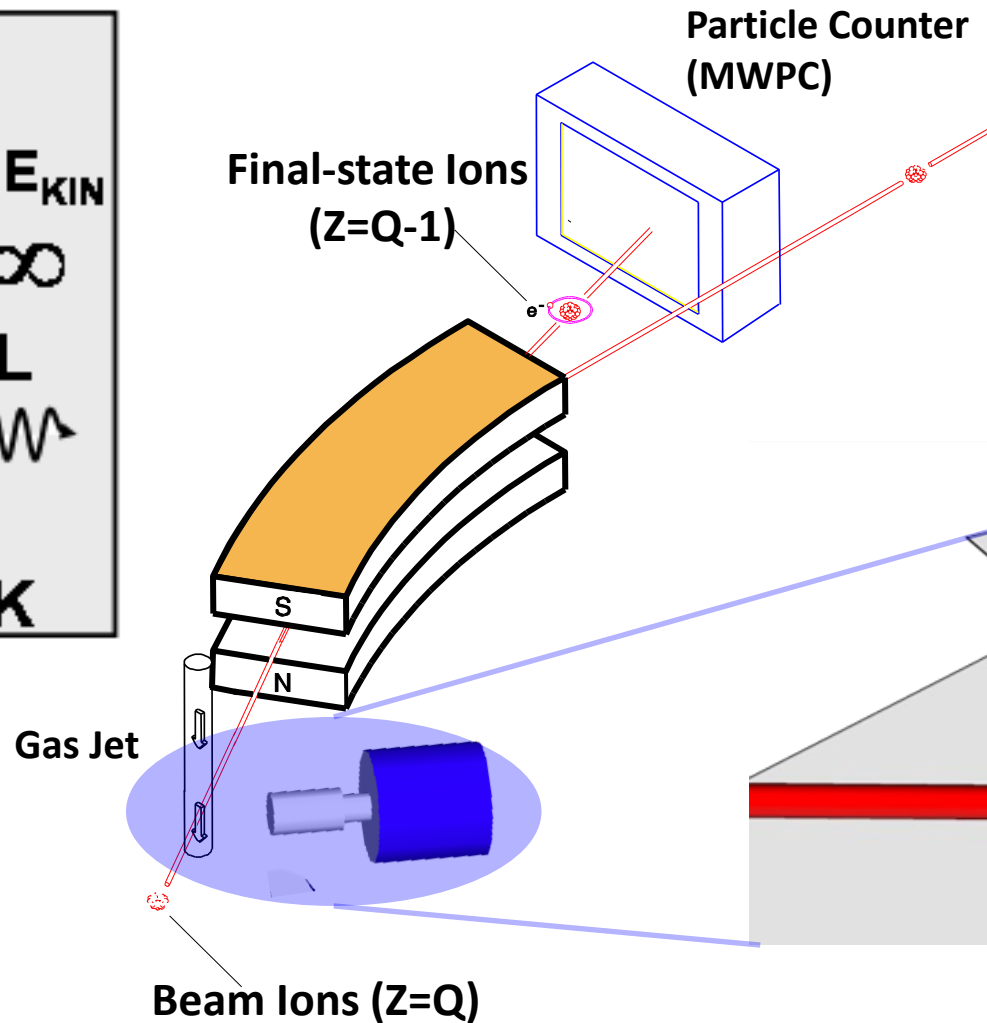
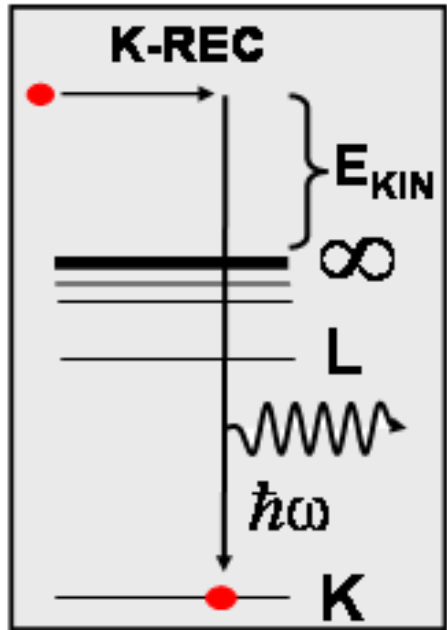

courtesy of Prof. Thomas Stöhlker and Dr. Anna Mayorova

polarized gas target

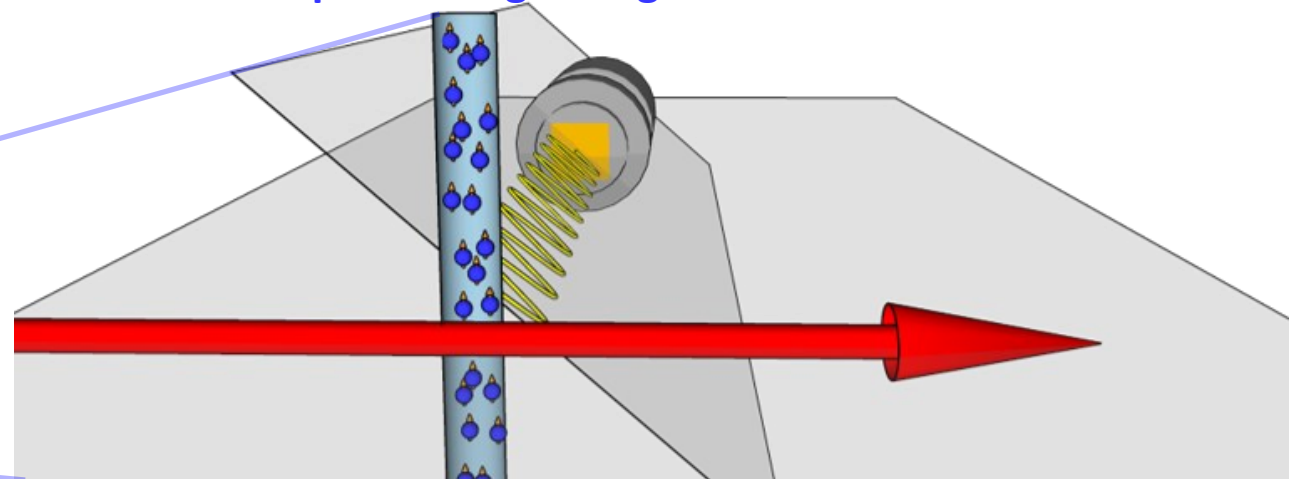

EoS and isovector force

EoS study with pol. d beam

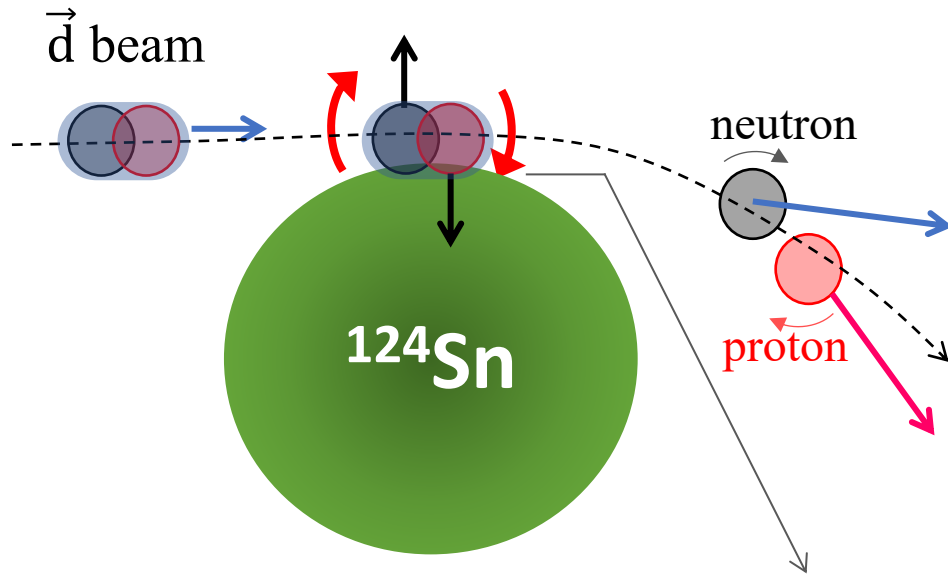

Due to the difference of nuclear forces neutron and proton experiences, **extra rotation** occurs !

Isovector force

- $F_v \propto \delta^2 \frac{dE_{\text{sym}}}{d\rho} \frac{d\rho}{dr} \left(\delta = \frac{\rho_n - \rho_p}{\rho} \right)$
- Attractive to p , repulsive to n
- Comparable with Coulomb force



courtesy of Prof. Zhigang Xiao

PRL 115, 212501 (2015); **PRC 101**, 024603 (2020)

- Coulomb force: leads to *Coulomb polarization* (Oppenheimer et al., 1935)
- Isovector force: leads to *isovector reorientation* (**IVR**)

EoS study with pol. d beam

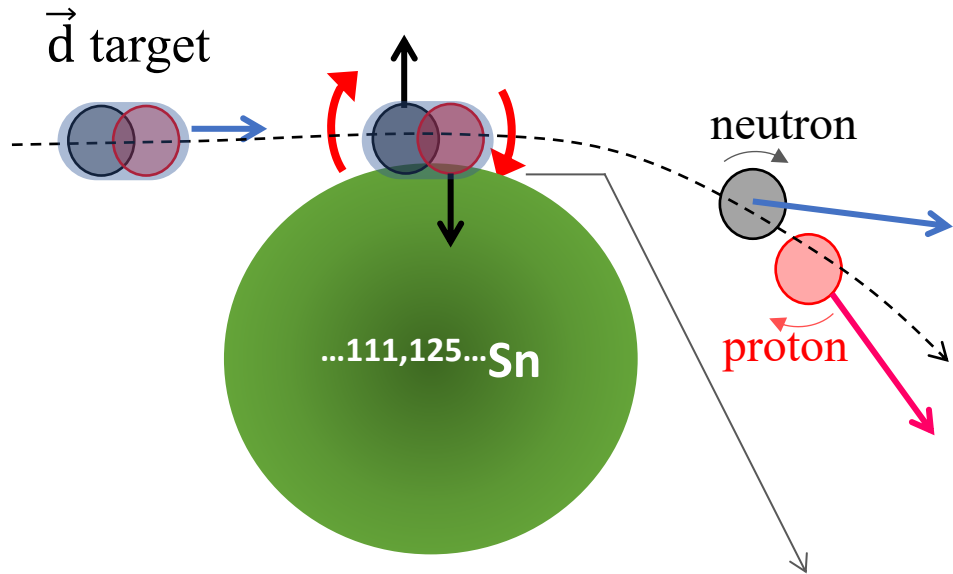

Due to the difference of nuclear forces neutron & proton experiences, **extra rotation** occurs!

PRL 115, 212501 (2015); PRC 101, 024603 (2020)

- Coulomb force: leads to *Coulomb precession*
- Isovector force: leads to *isovector rotation*

Isovector force

- $F_v \propto \delta^2 \frac{dE_{\text{sym}}}{d\rho} \frac{d\rho}{dr} \left(\delta = \frac{\rho_n - \rho_p}{\rho} \right)$
- Attractive to p , repulsive to n
- Comparable with Coulomb force

\vec{d} target and RI beams at SRing



δ dependence

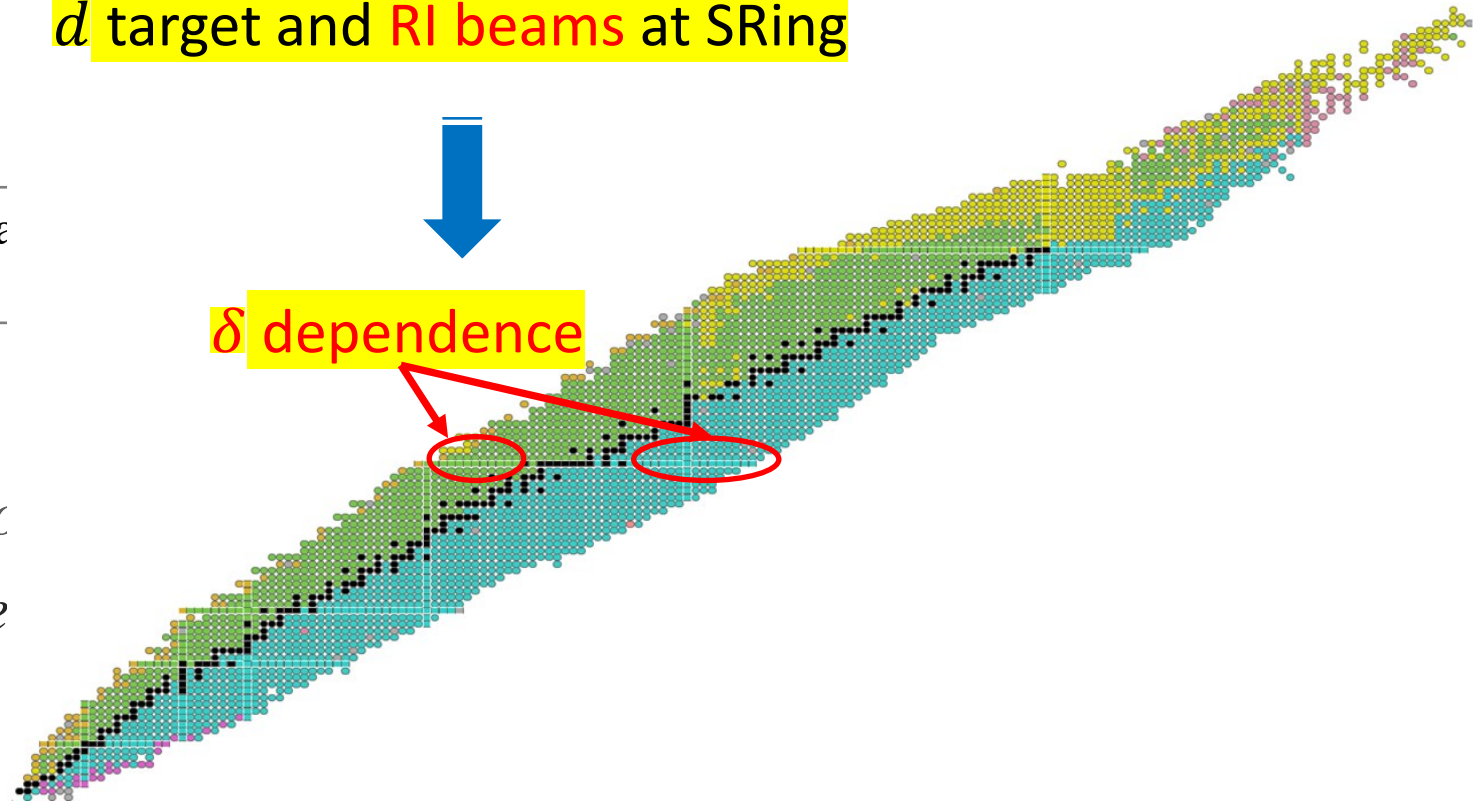

New boson search

T-odd effects with transverse spin asymmetry

- transverse single spin asymmetry (A_{\perp}) is a T-odd observable
- arises from two-photon exchange in electron elastic scattering

$$A_{\perp} \propto \frac{\text{Im}(\mathcal{M}_{\gamma}^* \mathcal{M}_{2\gamma})}{|\mathcal{M}_{\gamma}|^2} \sim \alpha_{EM} \sim 10^{-2}$$

Nucl. Phys. B 35 (1971) 365.

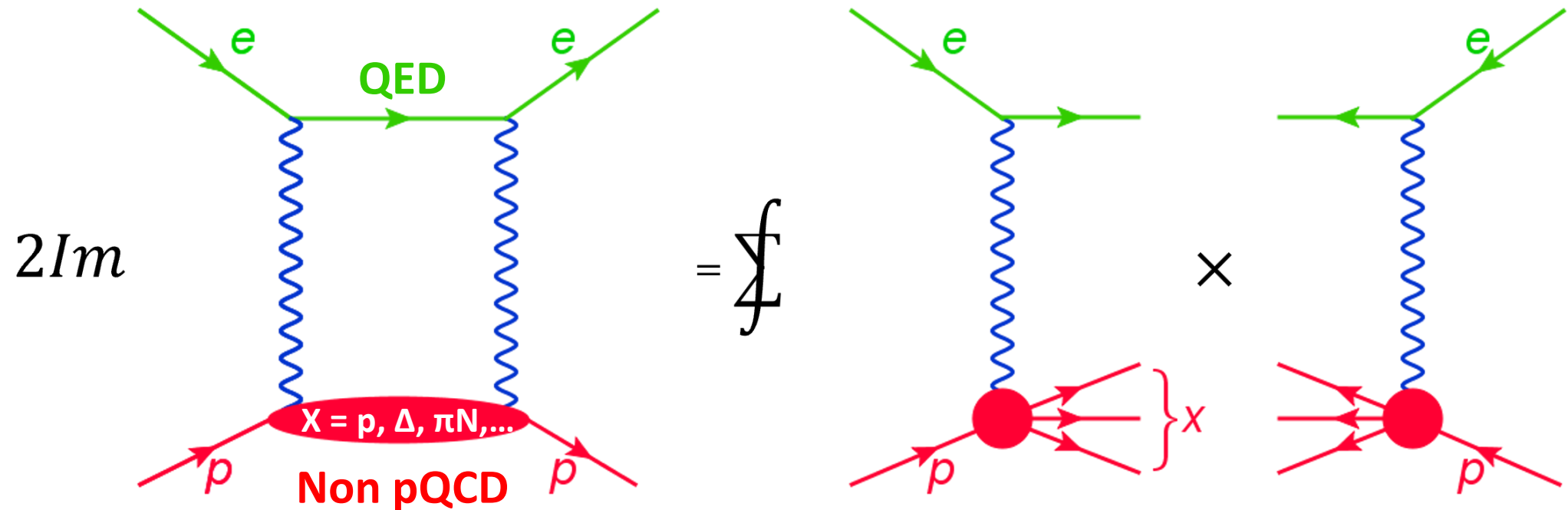

T-odd effects with transverse spin asymmetry

- transverse single spin asymmetry (A_{\perp}) is a T-odd observable
- arises from two-photon exchange in electron elastic scattering

$$A_{\perp} \propto \frac{\text{Im}(\mathcal{M}_{\gamma}^* \mathcal{M}_{2\gamma})}{|\mathcal{M}_{\gamma}|^2} \sim \alpha_{EM} \sim 10^{-2}$$

Nucl. Phys. B 35 (1971) 365.

Relativistic suppression ($1/\gamma$)
for transversely pol. beam



10^{-6}

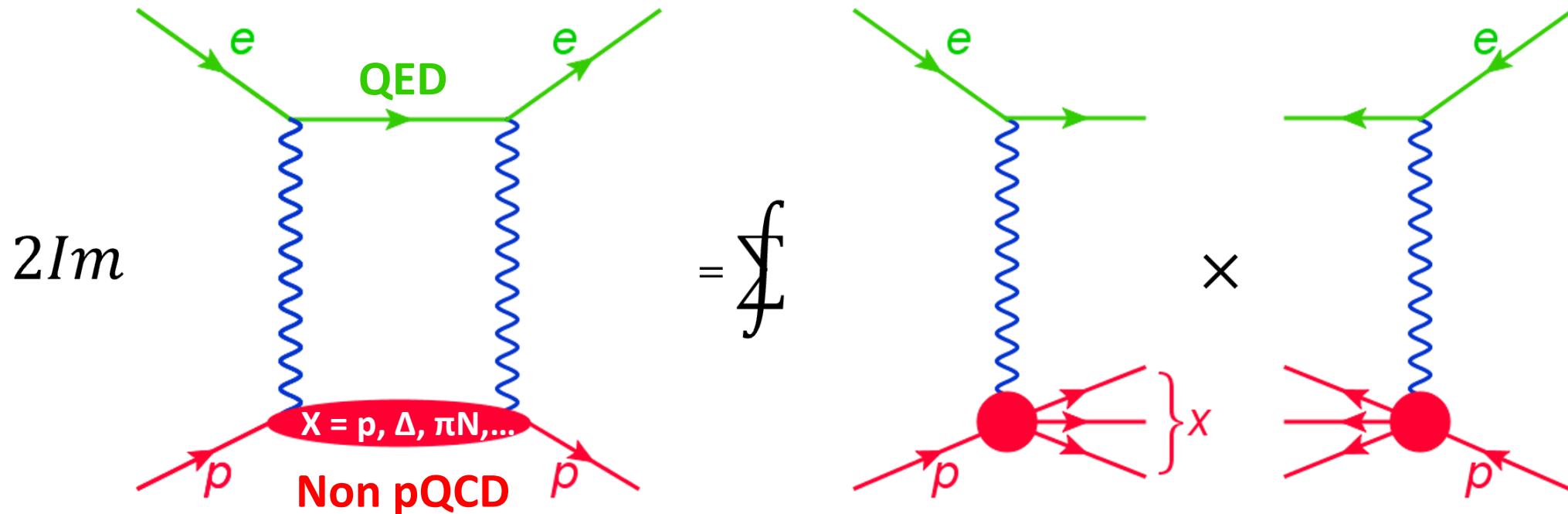

Exp. data vs calculation ($A_{\perp}^{\bar{e}p}$)

- surprising discrepancies between theory and exp. data
- observed at different laboratories
- not only in $\bar{e}p$, but also in $\bar{e}A$

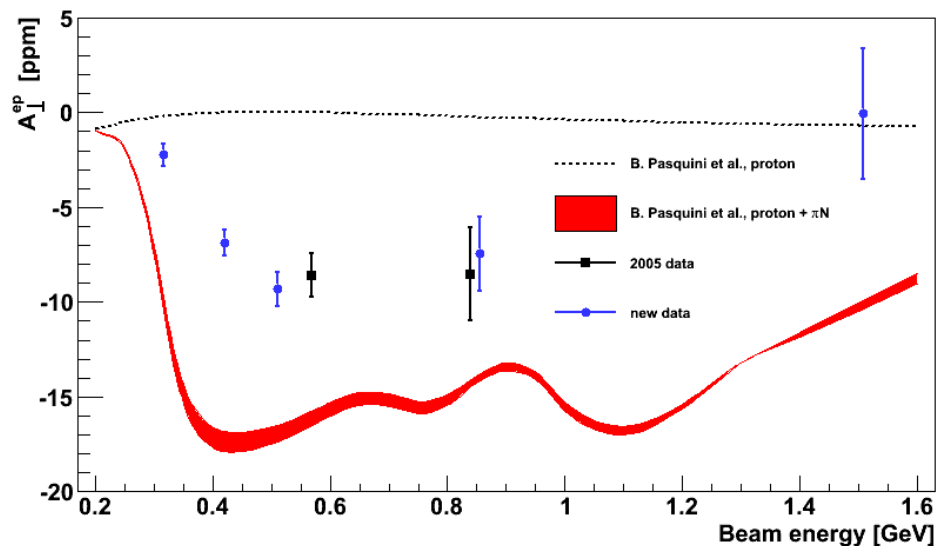

A4 @ MAMI

Phy. Rev. Lett. 124, 122003 (2020)

Phy. Rev. Lett. 94, 082001 (2005)

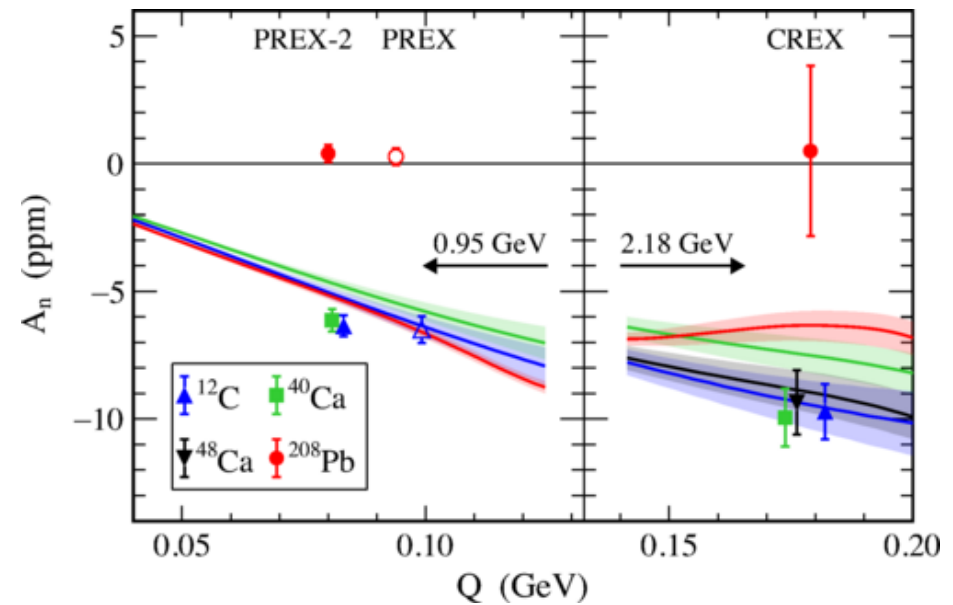

PREX, PREXII, CREX @ JLab

Phy. Rev. Lett. 109, 192501(2012)

Phy. Rev. Lett. 128, 142501(2022)

How to understand the surprise

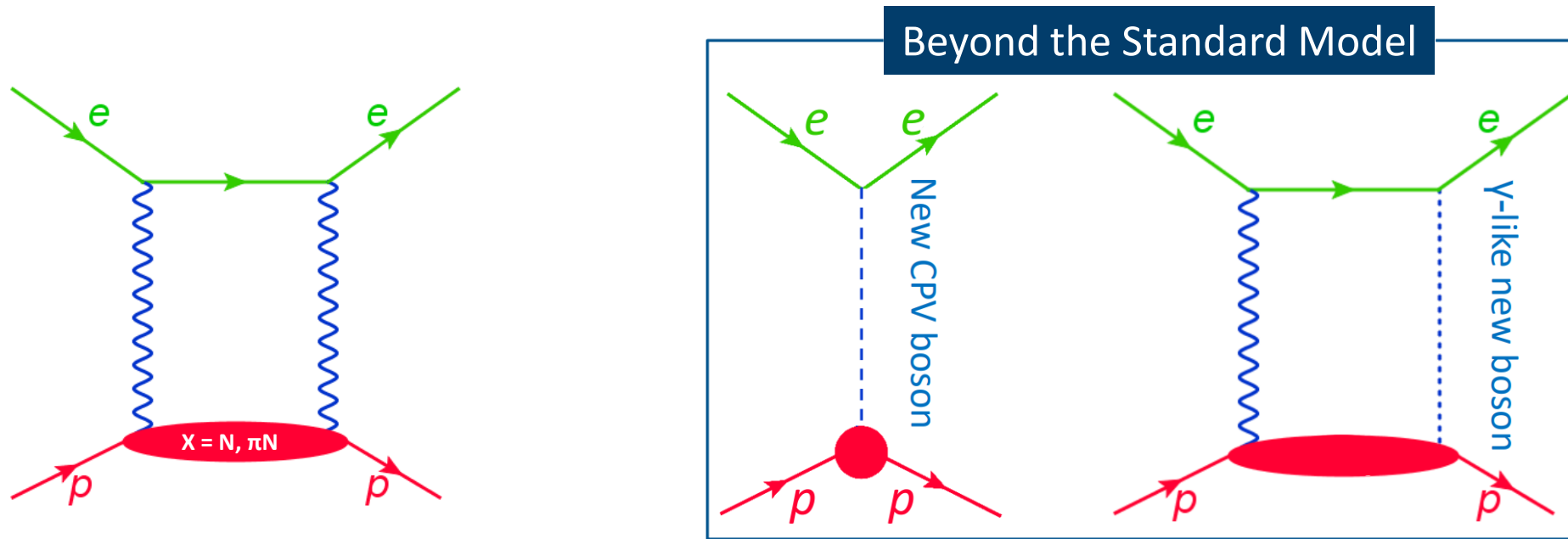

- More intermediate state?
- MAID database and CLAS data need improvement?
- **New unknown boson?**
- Hard to test new-physics hypothesis in $\vec{e}p \rightarrow ep$
 - Possible intermediates: $X = N, \pi N \dots \rightarrow$ **Non-pQCD uncertainty**
 - Lorentz effect with transverse \vec{e} beam $\rightarrow A_{\perp} \propto \frac{m_e}{E} \sim 10^{-6}$ (**tiny signal**)

New idea: $p\bar{e} \rightarrow pe$?

With **proton beam** and **electron target**, ultra low $Q_2 (< 1 \times 10^{-5})$ accessed in pe scattering

Reminder: Q_2 in ep scattering ($10^{-2} \sim 10^{-1}$)

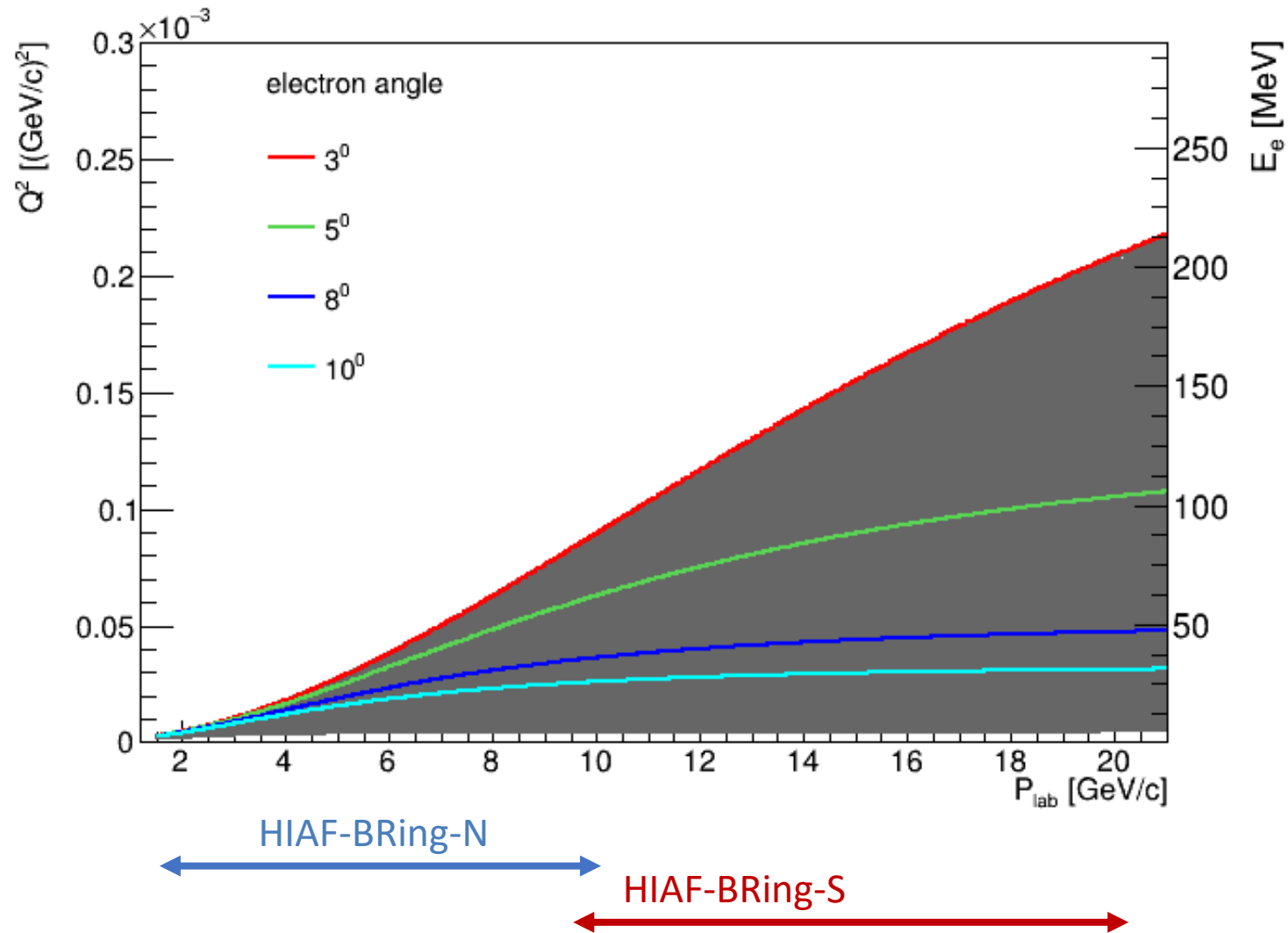

Transverse spin asymmetry: $p\bar{e}$ vs $\bar{e}p$

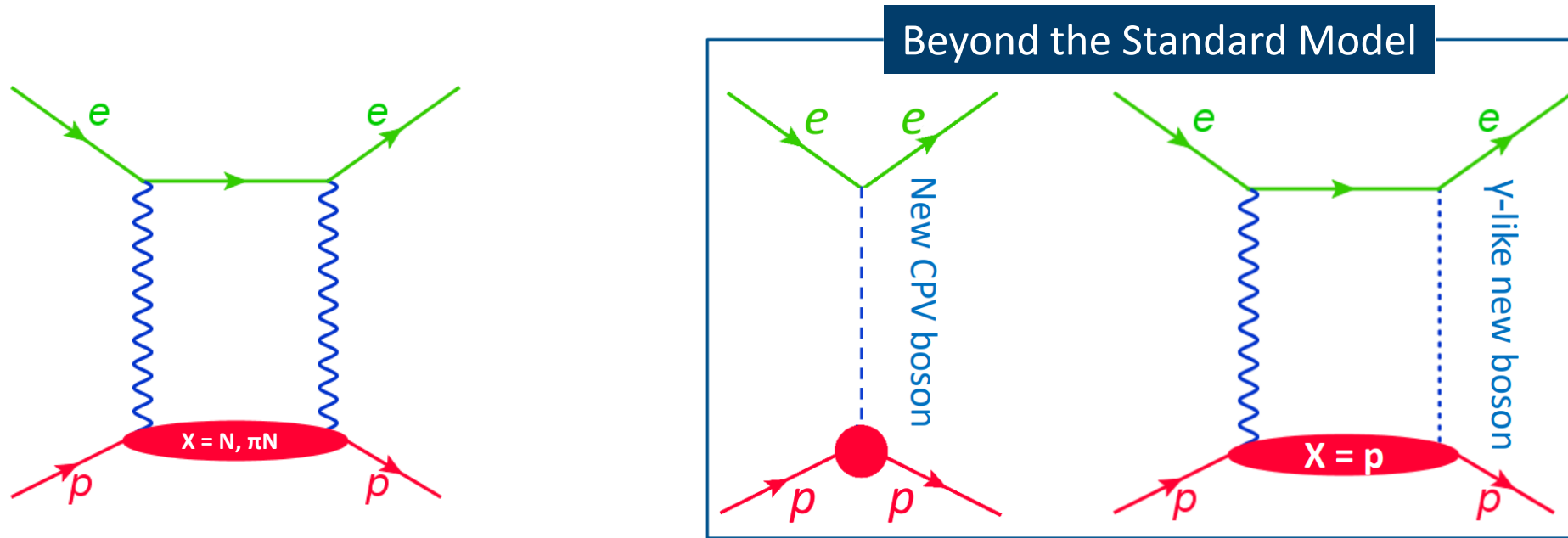

- **New unknown boson?**

- In $\bar{e}p \rightarrow ep$

- possible intermediates: $X = N, \pi N \dots \rightarrow$ **Non-pQCD uncertainty**
- Lorentz effect with transverse \bar{e} beam $\rightarrow A_{\perp} \propto \frac{m_e}{E} \sim 10^{-6}$ (**tiny signal**)

- In $p\bar{e} \rightarrow pe$ (very-low Q_2)

- $X = N \rightarrow A_{\perp}$ calculated with **G_E and G_M (no theoretical uncertainty)**
- No Lorentz effect $\rightarrow A_{\perp}$ **increases by 3 orders**

Detection system

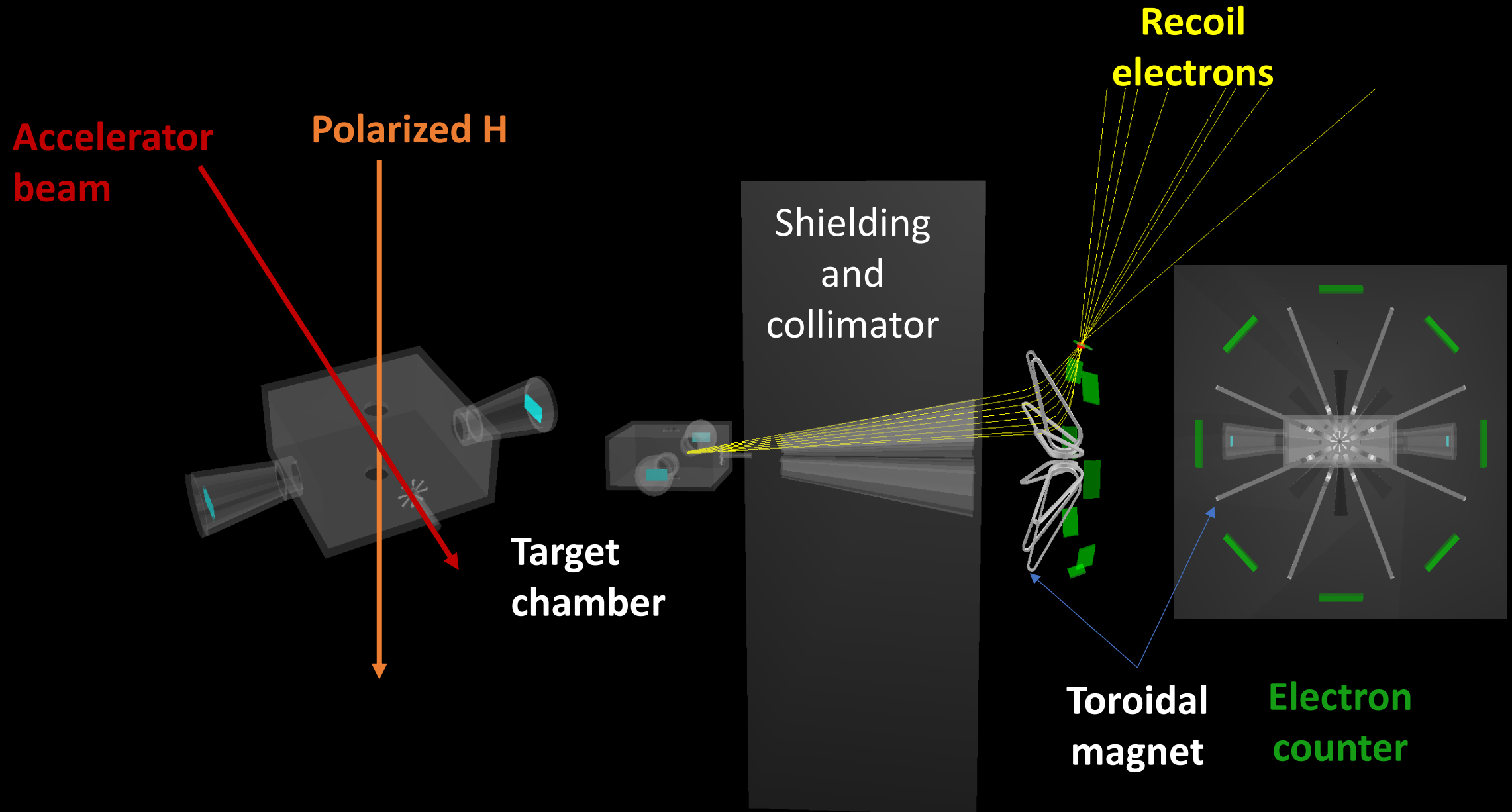

Detection system

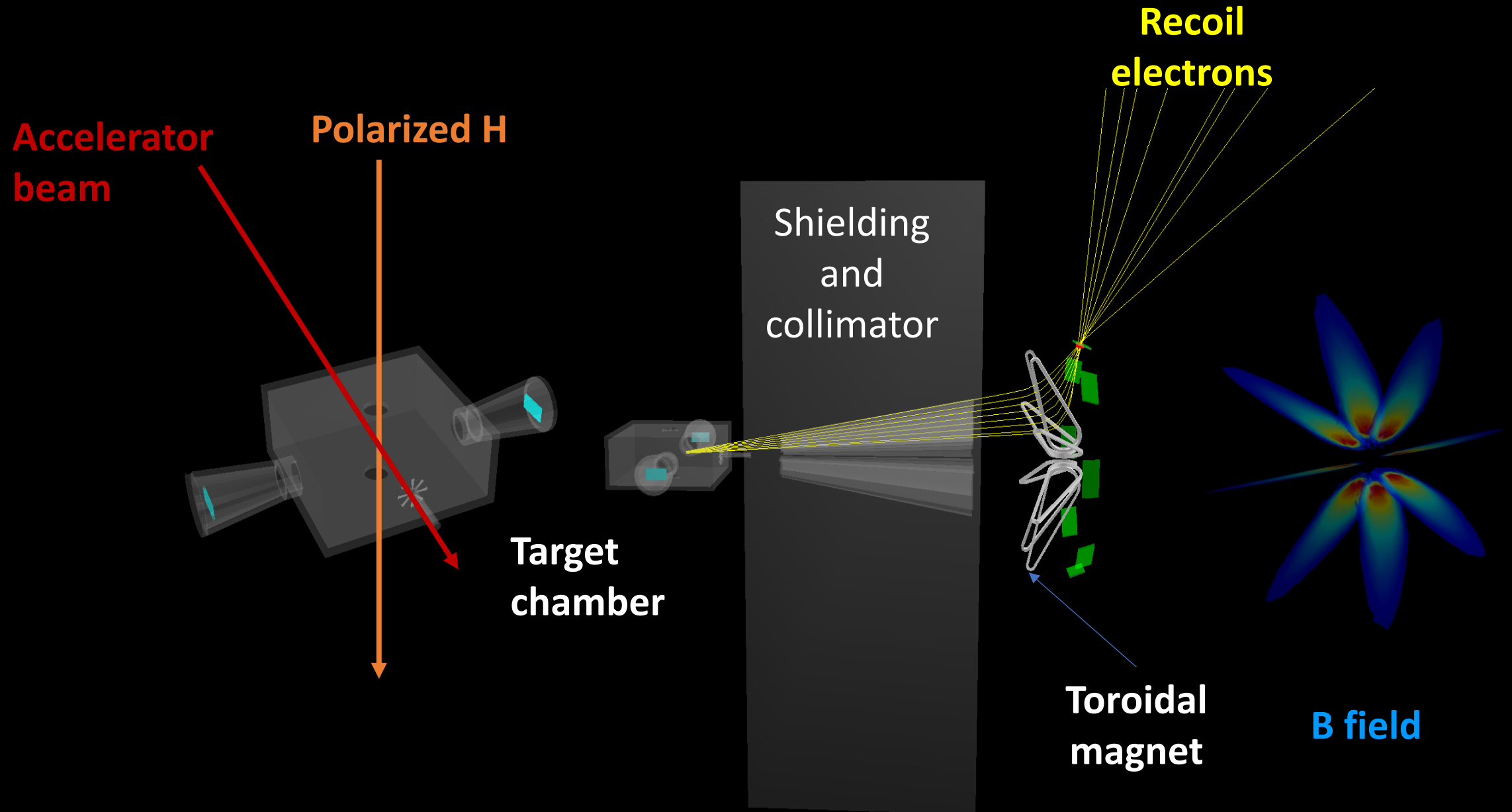

Test of time-reversal symmetry

Why time-reversal **a**symmetry?

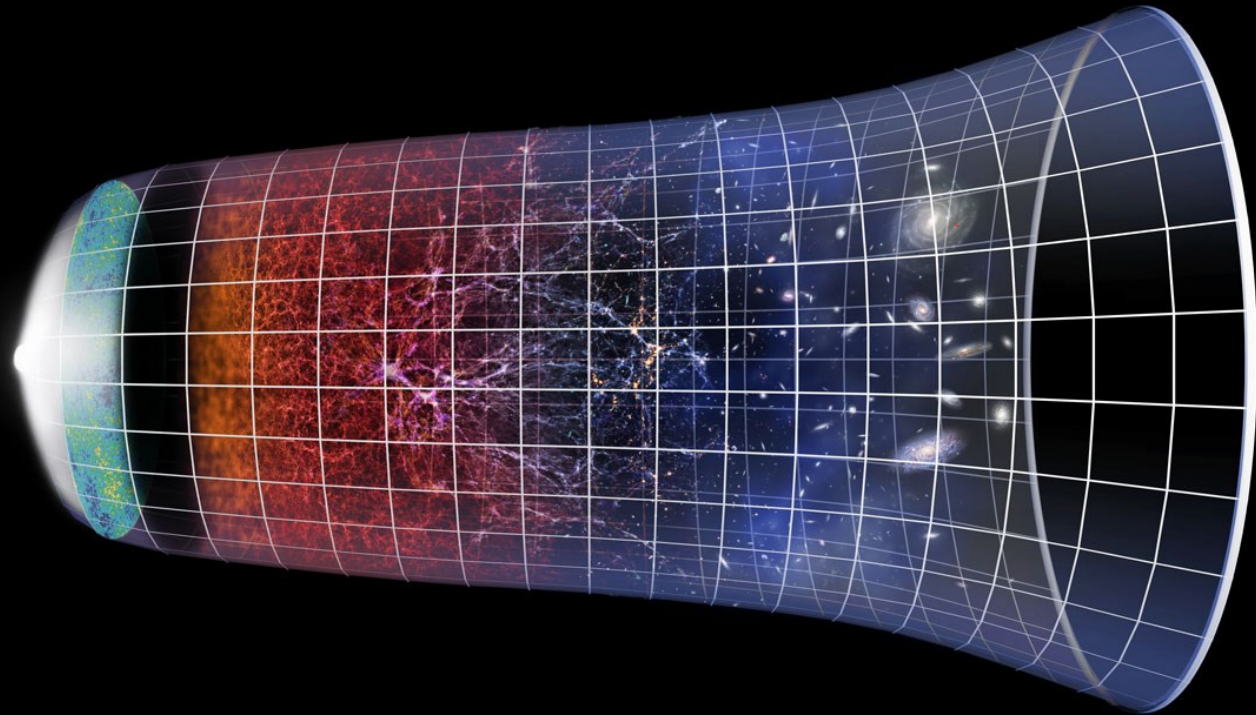

Excess of mater in the universe

Observation

$$\eta \equiv \frac{n_B - n_{\bar{B}}}{n_\gamma} = (6.11 \pm 0.19) \times 10^{-10}$$

SM predication

$\sim 10^{-18}$

New sources of CP violation must exist

Big Bang \rightarrow ~~CP~~ \rightarrow Today

CP $\xleftrightarrow{\text{CPT}}$ T

Why time-reversal **a**symmetry?

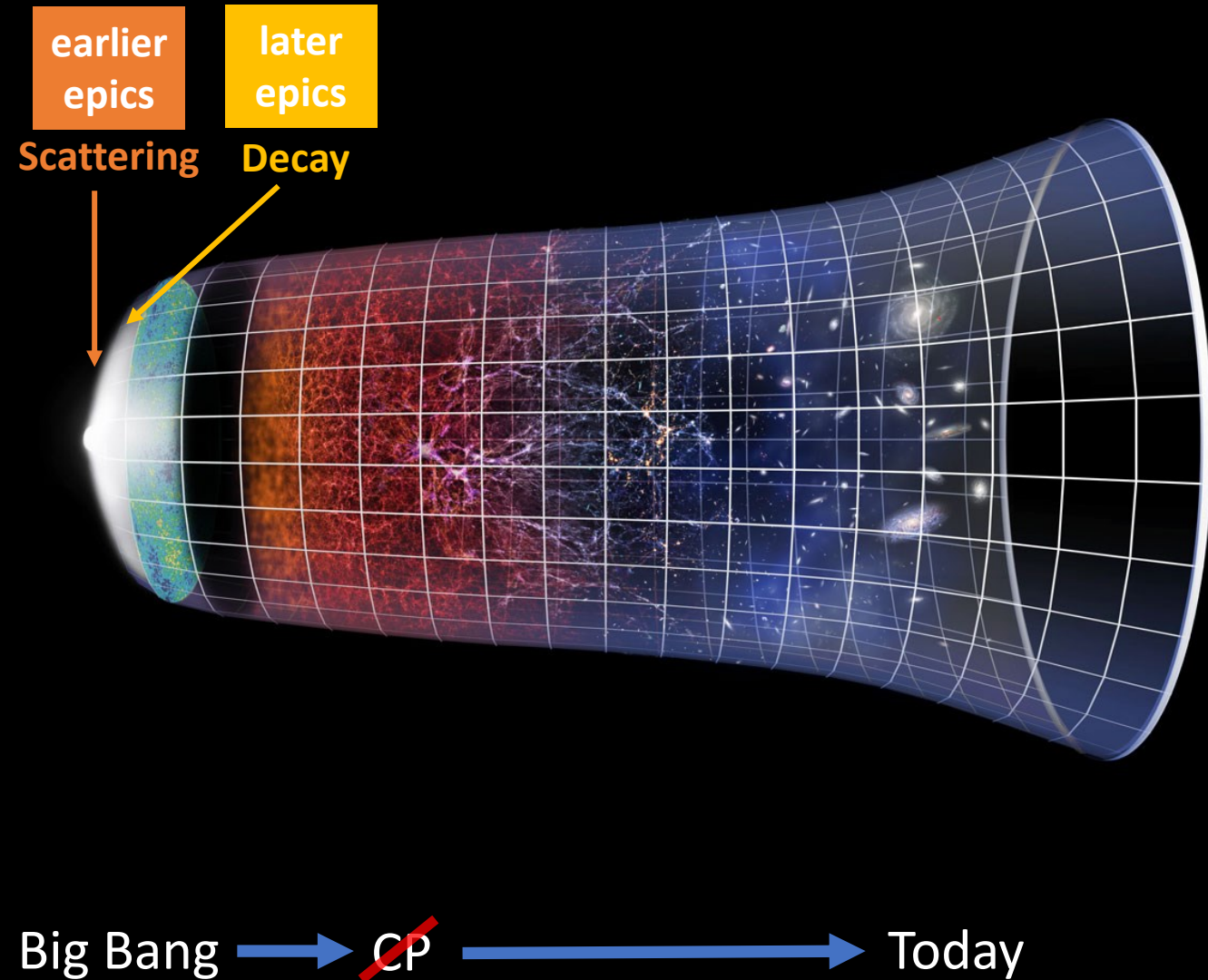

Excess of mater in the universe

Observation

$$\eta \equiv \frac{n_B - n_{\bar{B}}}{n_\gamma} = (6.11 \pm 0.19) \times 10^{-10}$$

SM predication

$\sim 10^{-18}$

New sources of CP violation must exist



Test time-reversal symmetry with \vec{p} \vec{d} scattering



What is time reversal?

- Flip momentum and spin for all particles
- Exchange initial and final states

Test time-reversal symmetry with \vec{p} \vec{d} scattering

Parity conserving (unlike EDM)
Time-reversal violating

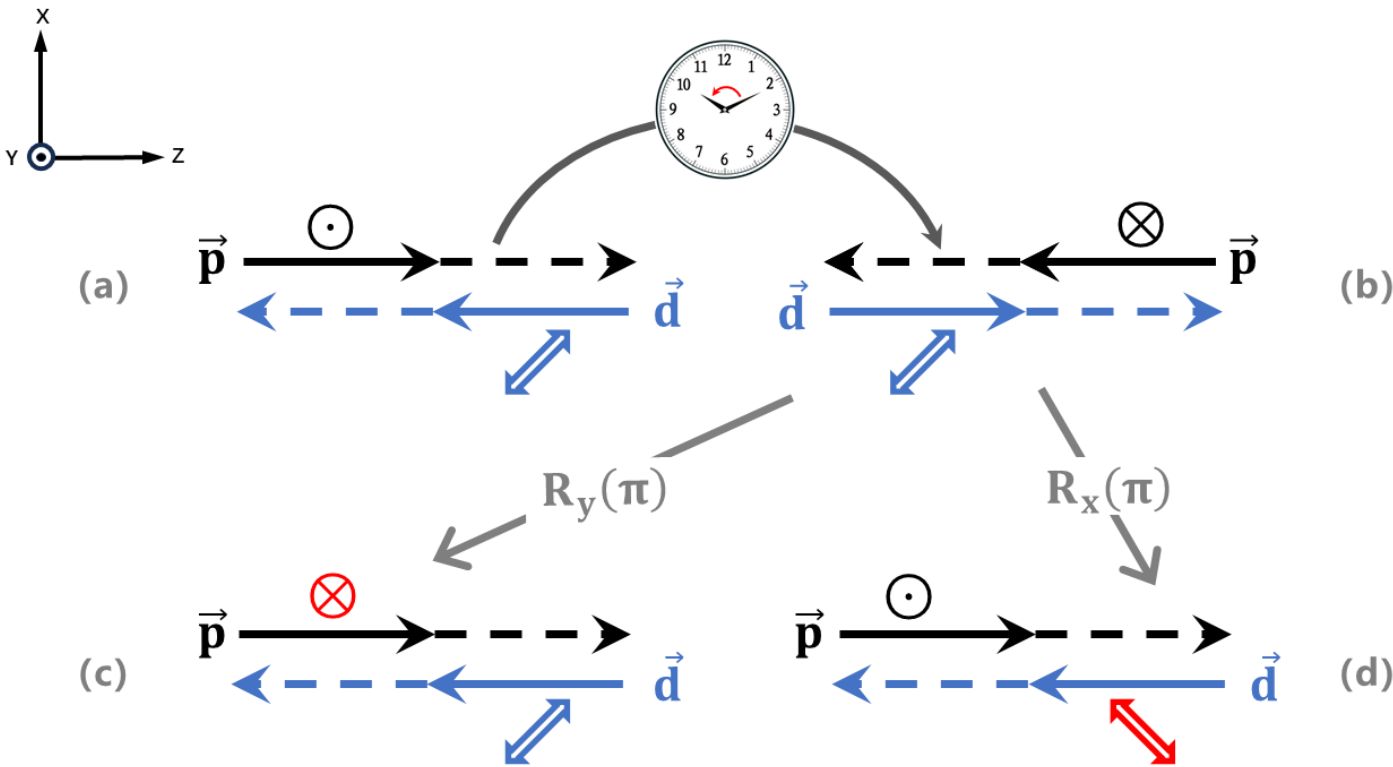

What is time reversal?

- Flip momentum and spin for all particles
- Exchange initial and final states
- Equivalent to spin flip (at forward scattering/ $\theta = 0^\circ$)
- Optical theorem

$$\frac{4\pi}{k} \text{Im} F^{el}(0^\circ) = \sigma_{total}$$

$$\sigma_{total}^\uparrow = \bar{\sigma}_{total} (1 + P_Y \cdot P_{XZ} \cdot A_{Y,XZ})$$

$$\sigma_{total}^\downarrow = \bar{\sigma}_{total} (1 - P_Y \cdot P_{XZ} \cdot A_{Y,XZ})$$

What do we need

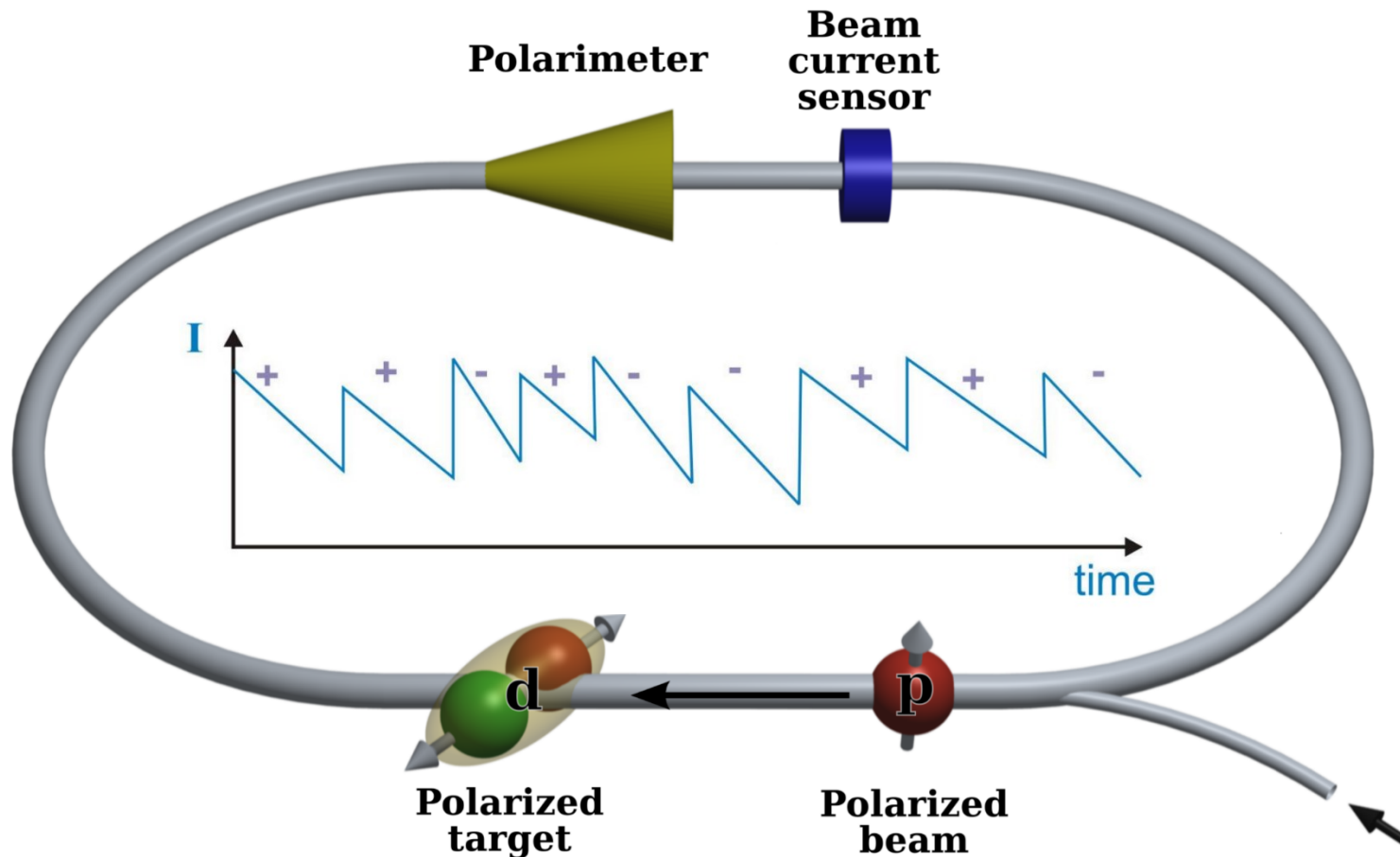

plot adopted from PAX and TRIC publications

$$\sigma_{total}^{\uparrow\downarrow} = \bar{\sigma}_{total} (1 \pm P_Y \cdot P_{XZ} \cdot A_{Y,XZ})$$

- polarized proton $\rightarrow P_Y$
- polarized deuteron $\rightarrow P_{XZ}$
- beam current monitor $\rightarrow \sigma_{total}^{\uparrow\downarrow}$

Test of time-reversal symmetry

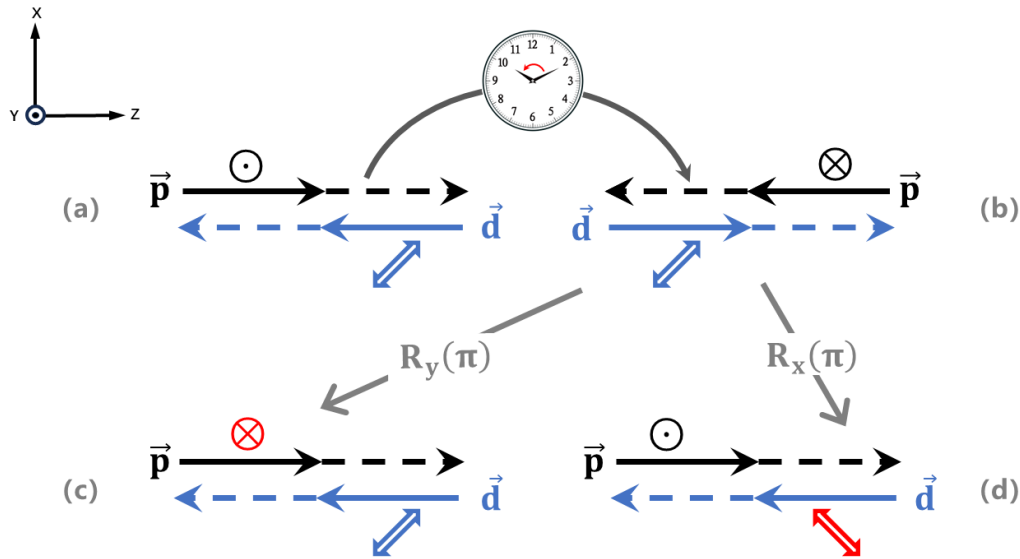

Proposed since early 1990s

H. E. Conzett. Null tests of time-reversal invariance. Phys. Rev. C 48, 423 (1993)

<https://tric-experiment.hiskp.uni-bonn.de/>

<https://www.fz-juelich.de/en/ikp/ikp-2/research/previous-list/tric>

[P. Lenisa et al. EPJ Tech. Instr. \(2019\) 6](#)

Challenges

✓ Signal asymmetry ($A_{y,xz}$)

■ Instrumental background asymmetry: nonperfect beam/target parameters ($\Delta E, \Delta X, \Delta X', \Delta I \dots$)

■ Physical background asymmetry: residual vector polarization of deuteron ($P_y \rightarrow A_{y,y}$)

Test of time-reversal symmetry

New approach to search for parity-even and parity-odd time-reversal violation beyond the Standard Model in a storage ring

N.N. Nikolaev, F. Rathmann, A.J. Silenko, Yu.N. Uzikov

[Phys. Lett. B 811, 135983 \(2020\)](#)

Main idea

- Conceived in the JEDI collaboration
- **Beam polarization rotates** with an RF solenoid
- Experimental asymmetry oscillates
- False asymmetry easily separated via **Fourier analysis**

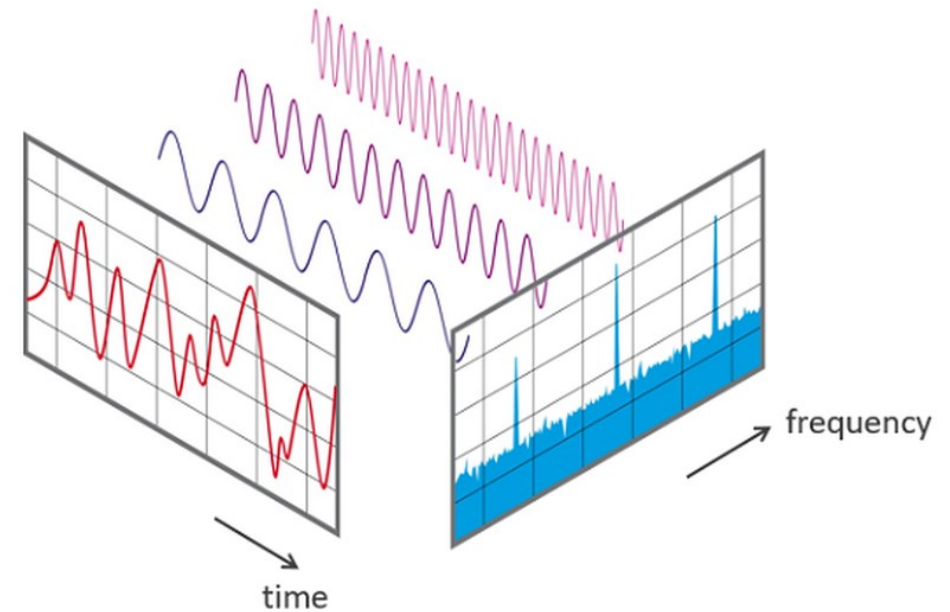

Test of time-reversal symmetry

New approach to search for parity-even and parity-odd time-reversal violation beyond the Standard Model in a storage ring

N.N. Nikolaev, F. Rathmann, A.J. Silenko, Yu.N. Uzikov

[Phys. Lett. B 811, 135983 \(2020\)](#)

Main idea

- Conceived in the JEDI collaboration
- **Beam polarization rotates** with an RF solenoid
- Experimental asymmetry oscillates
- False asymmetry easily separated via **Fourier analy.**

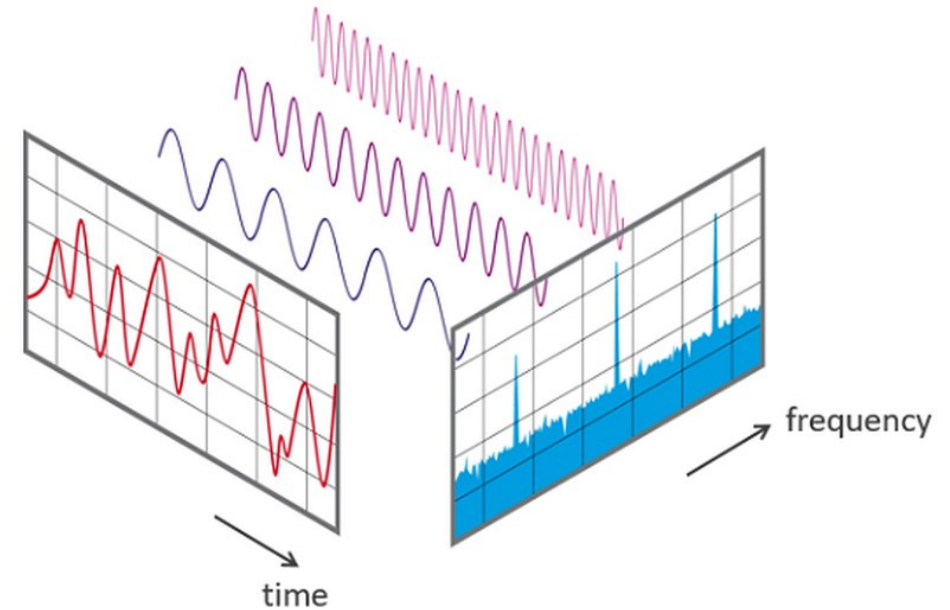

Spin-rotating polarized target?

Spin-rotating target

Spin-rotating polarized target

- Atoms polarized in pol. H/D gas target
- Electron spin aligned with the holding field at interaction point
- Proton/deuteron spin attached to electron spin (HF not too strong)
- Up to now, only static holding fields are used: transverse, longitudinal or superposed
- **How to make a rotating field?**
 - Triple coils driven by 3-phase rf current (proposed in this talk)
 - Static dipole \vec{B} superposed by perpendicular RF \vec{B}
 - proposed for NICA
 - private communication with N.N. Nikolaev

Spin-rotating polarized target

- Atoms polarized in pol. H/D gas target
- Electron spin aligned with the holding field at interaction point
- Proton/deuteron spin attached to electron spin (HF not too strong)
- Up to now, only static holding fields are used: transverse, longitudinal or superposed
- **How to make a rotating field?**
 - Triple coils driven by 3-phase rf current (proposed in this talk)
 - Static dipole \vec{B} superposed by perpendicular RF \vec{B}
 - proposed for NICA
 - private communication with N.N. Nikolaev

It was really joyful that Prof. Nikolaev who was trying to contact HIAF-SPIN team, was introduced to me just a few days after I was inspired by their fantastic paper, when we surprisingly found out that we had similar ideas!!!

Rotating magnetic field

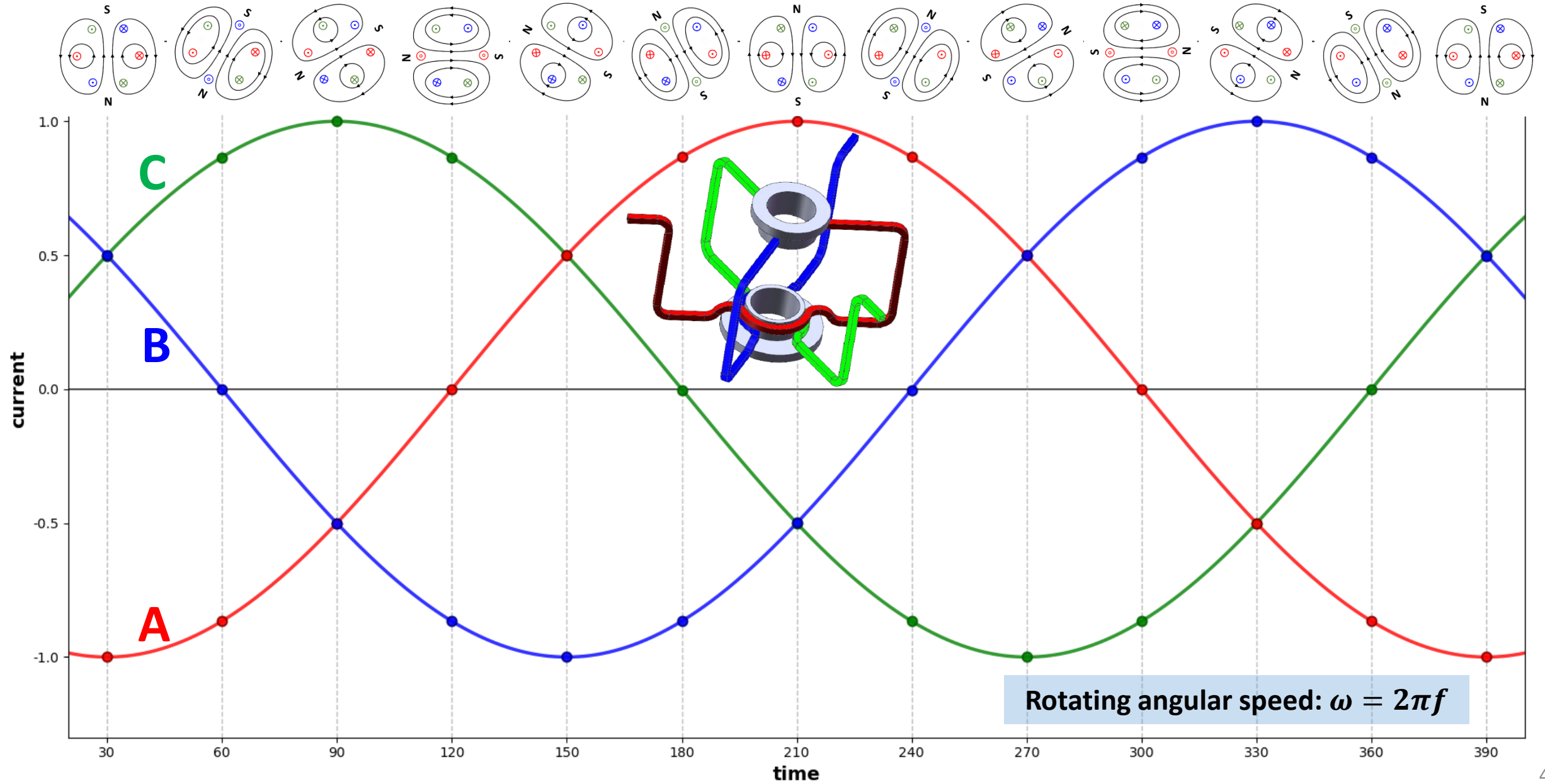

Spin-rotating polarized target

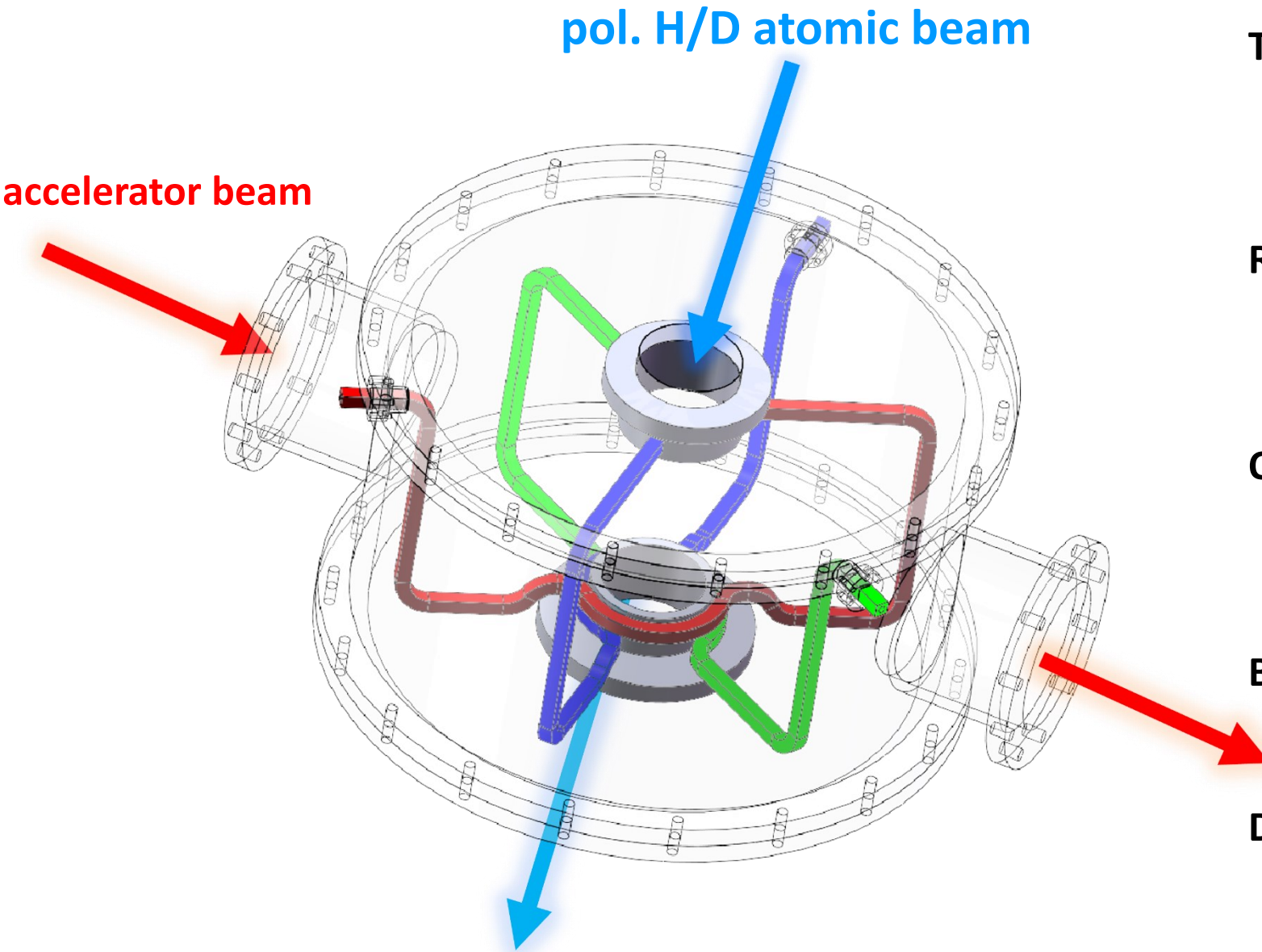

Triple coil (ABC) carrying 3-phase AC



Rotating dipole \vec{B} & spin



Oscillating physical asymmetry



Background symmetry separated by FT

Discovery potential

- Time reversal violation ($\vec{p}\vec{d}$)
- Parity violation ($p\vec{p}$)
- ...

Roadmap

Roadmap

\vec{H}^+ / \vec{D}^+
ion source



target	beam	physics and observables
\vec{e}	charged ion beam	spin dependence of REC $Z^{Q+} + e^- \rightarrow Z^{(Q-1)+} + \hbar\omega$
	p	A_{\perp} in $p\vec{e} \rightarrow pe$ proton EM radii, new boson search
\vec{p}	p, d, A \vec{p}, \vec{d}	A_N, A_{NN} in $p\vec{p}, A\vec{p}, \vec{p}\vec{p}, \vec{n}\vec{p} \dots$ NN interaction, NA spin dynamics
heavy-ion target (A)	\vec{d}	isovector force induced \vec{d} rotation in $\vec{d}A \rightarrow pnA$ symmetry energy in EOS
\vec{d}	radioactive beams (A)	
	\vec{p}	$A_{y,xz}(0)$ in $\vec{p}\vec{d} \rightarrow pd$ time-reversal symmetry test

Atomic physics

New boson search

bread-and-butter physics

Nuclear physics

Fundamental symmetry

Roadmap

\vec{H}^+ / \vec{D}^+
ion source

\vec{d} beam
low-energy station



target	beam	physics and observables
\vec{e}	charged ion beam	spin dependence of REC $Z^{Q+} + e^- \rightarrow Z^{(Q-1)+} + \hbar\omega$
	p	A_{\perp} in $p\vec{e} \rightarrow pe$ proton EM radii, new boson search
\vec{p}	p, d, A \vec{p}, \vec{d}	A_N, A_{NN} in $p\vec{p}, A\vec{p}, \vec{p}\vec{p}, \vec{n}\vec{p} \dots$ NN interaction, NA spin dynamics
heavy-ion target (A)	\vec{d}	isovector force induced \vec{d} rotation in $\vec{d}A \rightarrow pnA$ symmetry energy in EOS
\vec{d}	radioactive beams (A)	
	\vec{p}	$A_{y,xz}(0)$ in $\vec{p}\vec{d} \rightarrow pd$ time-reversal symmetry test

Atomic physics

New boson search

bread-and-butter physics

Nuclear physics

Fundamental symmetry

Roadmap



target	beam	physics and observables
\vec{e}	charged ion beam	spin dependence of REC $Z^{Q+} + e^- \rightarrow Z^{(Q-1)+} + \hbar\omega$
	p	A_{\perp} in $p\vec{e} \rightarrow pe$ proton EM radii, new boson search
\vec{p}	p, d, A \vec{p}, \vec{d}	A_N, A_{NN} in $p\vec{p}, A\vec{p}, \vec{p}\vec{p}, \vec{n}\vec{p} \dots$ NN interaction, NA spin dynamics
heavy-ion target (A)	\vec{d}	isovector force induced \vec{d} rotation
	radioactive beams (A)	in $\vec{d}A \rightarrow pnA$ symmetry energy in EOS
\vec{d}	\vec{p}	$A_{y,xz}(0)$ in $\vec{p}\vec{d} \rightarrow pd$ time-reversal symmetry test

Atomic physics

New boson search

bread-and-butter physics

Nuclear physics

Fundamental symmetry

Roadmap

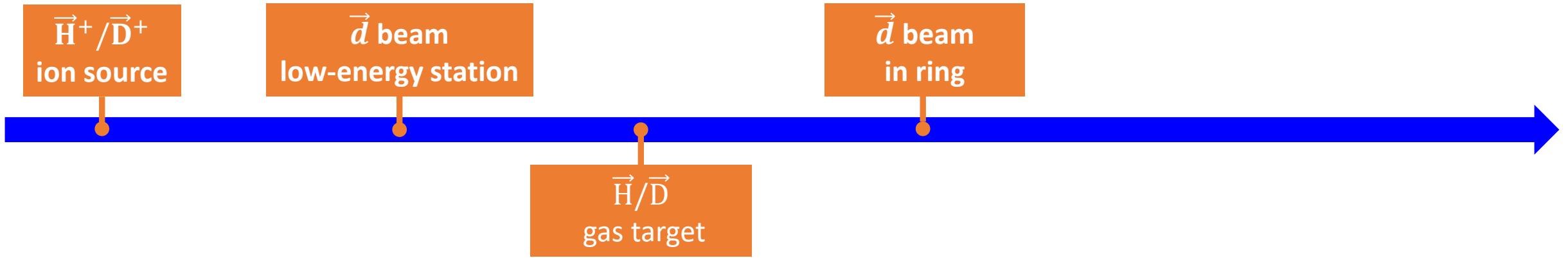

target	beam	physics and observables
\vec{e}	charged ion beam	spin dependence of REC $Z^{Q+} + e^- \rightarrow Z^{(Q-1)+} + \hbar\omega$
	p	A_{\perp} in $p\vec{e} \rightarrow pe$ proton EM radii, new boson search
\vec{p}	p, d, A \vec{p}, \vec{d}	A_N, A_{NN} in $p\vec{p}, A\vec{p}, \vec{p}\vec{p}, \vec{n}\vec{p} \dots$ NN interaction, NA spin dynamics
heavy-ion target (A)	\vec{d}	isovector force induced \vec{d} rotation
	radioactive beams (A)	in $\vec{d}A \rightarrow pnA$ symmetry energy in EOS
\vec{d}	\vec{p}	$A_{y,xz}(0)$ in $\vec{p}\vec{d} \rightarrow pd$ time-reversal symmetry test

Atomic physics

New boson search

bread-and-butter physics

Nuclear physics

Fundamental symmetry

Roadmap

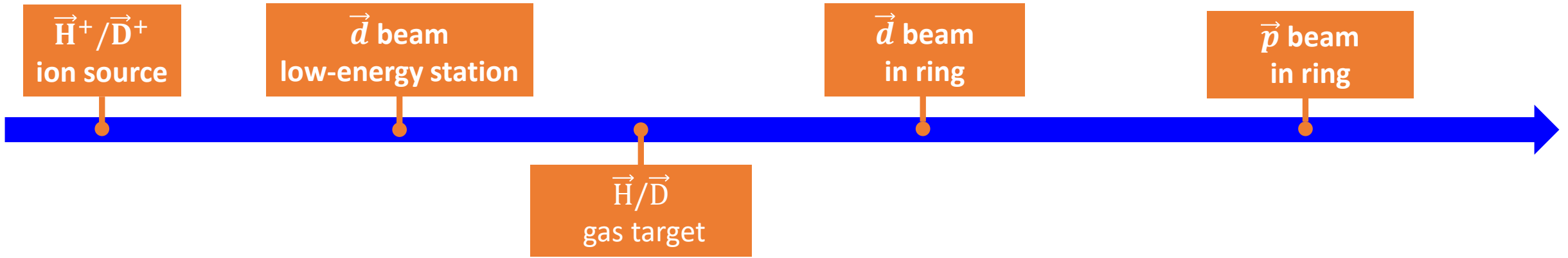

target	beam	physics and observables
\vec{e}	charged ion beam	spin dependence of REC $Z^{Q+} + e^- \rightarrow Z^{(Q-1)+} + \hbar\omega$
	p	A_{\perp} in $p\vec{e} \rightarrow pe$ proton EM radii, new boson search
\vec{p}	p, d, A \vec{p}, \vec{d}	A_N, A_{NN} in $p\vec{p}, A\vec{p}, \vec{p}\vec{p}, \vec{n}\vec{p} \dots$ NN interaction, NA spin dynamics
heavy-ion target (A)	\vec{d}	isovector force induced \vec{d} rotation
	radioactive beams (A)	in $\vec{d}A \rightarrow pnA$ symmetry energy in EOS
\vec{d}	\vec{p}	$A_{y,xz}(0)$ in $\vec{p}\vec{d} \rightarrow pd$ time-reversal symmetry test

Atomic physics

New boson search

bread-and-butter physics

Nuclear physics

Fundamental symmetry

Summary

- Tools for spin physics at HIAF being developed
- Physics with polarized beam/target at HIAF
 - Atomic, nuclear and hadron physics
 - New physics search with $p\vec{e}$
 - Test of time-reversal invariance with $\vec{p}\vec{d}$
 - Spin-rotating polarized target

Thank you!

Great Physics is yet to come!

